

# au-Lika

Type SUP040



EN

02

## OPERATING INSTRUCTIONS

Read these operating instructions carefully before using the machine.

CE

The Saeco logo, consisting of a stylized 'S' inside a circle followed by the word 'Saeco' in a bold, sans-serif font.

**1**

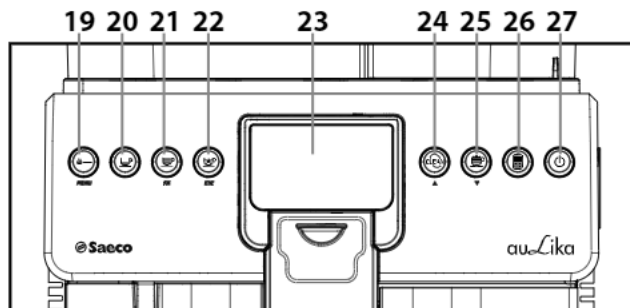
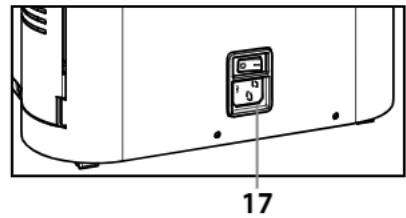
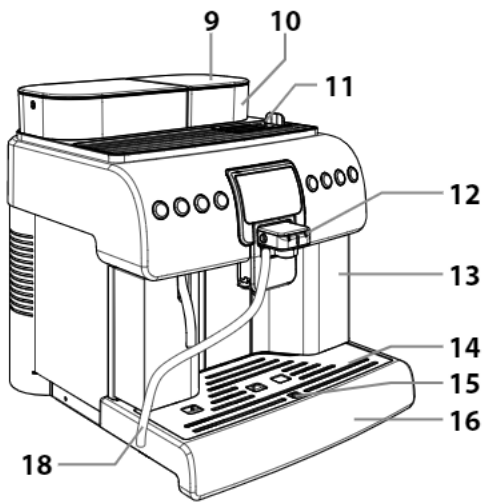
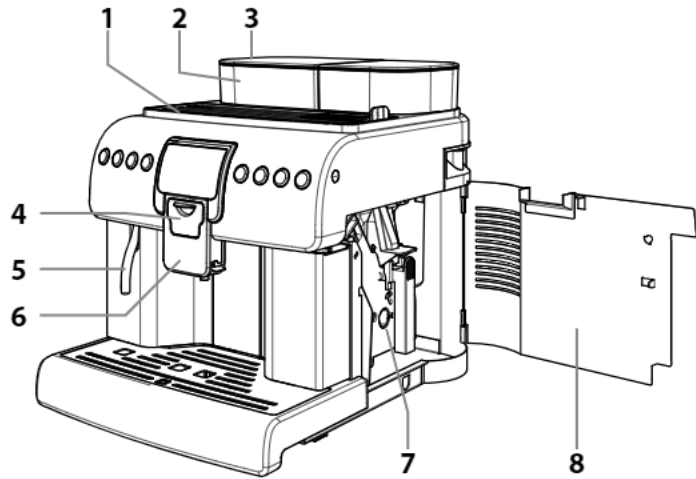

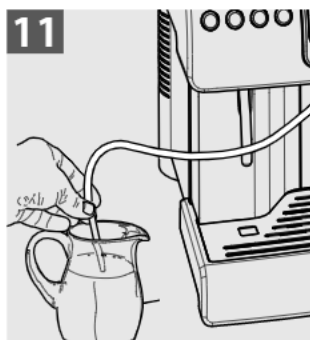
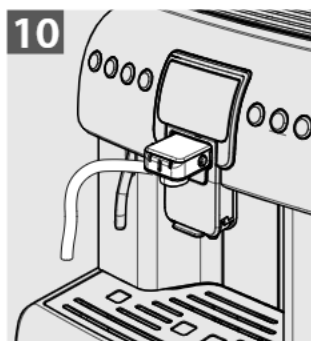
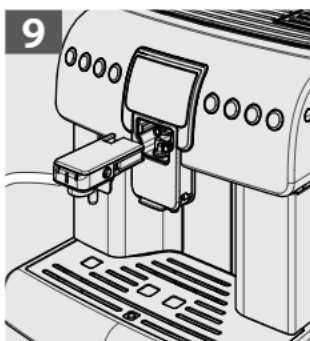
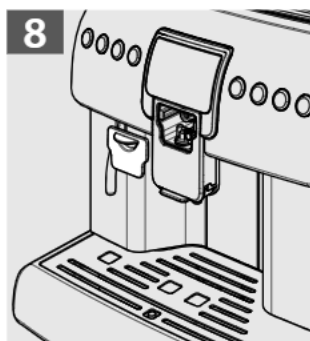
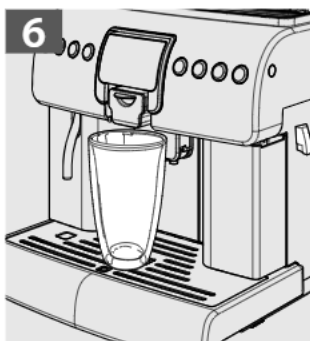
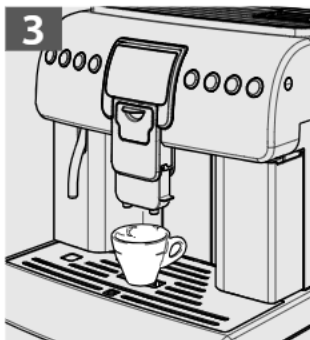
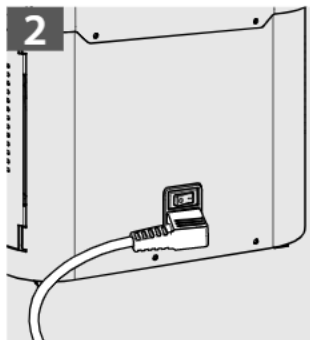

# SAFETY REGULATIONS



**Never allow water to come into contact with any of the electrical parts of the machine: danger of short circuit! Hot water and steam may cause scalding!**

## ***Intended Use***

The machine is intended to be used in small offices/organisations only.

The appliance is not to be used by persons (including children) with reduced physical, mental or sensory abilities or with scarce experience and/or expertise, unless they are supervised by a person responsible for their safety, or they are instructed by this person on how to properly use the machine.

## ***Power Supply***

The machine must be connected to the power supply by the service provider, in accordance with its specifications.

## ***Power Cord***

Never use the machine if the power cord is defective.

Report any defects in the cord and/or plug to the service provider immediately. Do not pass the power cord around corners, over sharp edges or over hot objects and keep it away from oil. Do not use the power cord to carry or pull the machine. Do not pull out the plug by the power cord or touch it with wet hands

or feet. Do not let the power cord hang freely from tables or shelves.

## ***For the Safety of Others***

Ensure that children cannot play with the machine and/or the packaging materials. Never direct the jet of hot water and/or steam towards yourself or others. Do not touch the hot water wand with bare hands. Always use the handles or knobs provided.

## ***Danger of Burns***

Do not touch the hot water wand and/or the coffee/beverage dispensing spout.

## ***Fire Safety Precautions***

In case of fire, use carbon dioxide (CO<sub>2</sub>) extinguishers. Do not use water or dry powder extinguishers.

## ***Suitable Location for Operation and Maintenance***

The machine should be installed by the service provider in accordance with the safety regulations in force at the time of installation.

The machine may only be moved by the service provider.

Do not use the machine outdoors.

Avoid placing open flames and/or incandescent objects near the machine so as not to damage or melt the machine housing. Do not use in places where the temperature may drop to a level equal to and/or lower than 0°C. If the machine has been exposed to such conditions,



alert the service provider, who will carry out a safety check.

### ***Cleaning***

Before cleaning the machine, the power button must be switched to OFF (0) and the plug must be removed from the power socket. Wait for the machine to cool down. Never immerse the machine in water! It is strictly forbidden to tamper with the internal parts of the machine. Do not clean the machine using a jet of water.

The appliance and its components must be cleaned and washed following a period of inactivity.

### ***Using Milk***

Milk must be used and stored in accordance with the instructions given on the manufacturer's original packaging.

We accept no liability for use of milk unsuitable for human consumption.

Milk must be kept cold, as high temperatures will make it turn sour - this is a natural characteristic of milk. For this reason, the Cappuccinatore must be cleaned after each use, as described in the manual.

For thorough cleaning, the Cappuccinatore can be detached and disassembled, and its parts can be put into a dishwasher (not of professional type).

Washing component parts in the dishwasher may cause Cappuccinatore surfaces to tarnish or the graphics to fade, especially if harsh detergents are used.

This circumstance is normal and does not affect the correct operation of the milk brewing system.

### ***Storing the Machine***

If the machine is to remain inactive for a long time, turn it off and unplug it. Store the machine in a dry place, out of the reach of children. Keep it protected from dust and dirt.

### ***Repairs / Maintenance***

In case of breakdown, defect or a suspected fault resulting from a fall, immediately remove the plug from the power socket and alert the service provider or specialised technician.

Never attempt to operate the machine if it is faulty. Only the service provider and/or technician may service or repair the machine.

## CONTENTS

<b>1 GENERAL INFORMATION</b> .....	<b>7</b>	8.2 Stop Functions .....	26
1.1 Intended Use of the Machine .....	7	8.3 List of Accessories .....	26
1.2 How to Read the Manual .....	7	8.3.1 List of accessories supplied .....	26
1.3 How to Use these Operating Instructions .....	7	8.3.2 List of optional accessories .....	26
1.4 Machine Identification .....	7	8.4 Assembly-Siting .....	27
1.5 Technical Specifications .....	8	8.5 Disposal of Packaging .....	27
1.6 Residual Risks .....	8	8.6 Filling the Water Tank .....	27
<b>2 MACHINE COMPONENTS</b> .....	<b>8</b>	8.7 Filling the Coffee Bean Hopper .....	27
2.1 Control Panel Description .....	9	8.8 Electrical Connection .....	27
<b>3 USING THE MACHINE</b> .....	<b>9</b>	8.9 Setting the Language (Upon First Use) .....	28
3.1 Filling the Water Tank .....	9	8.10 First Use - Use After a Long Period of Inactivity .....	28
3.2 Filling the Coffee Bean Hopper .....	10	8.11 Measuring and Adjusting Water Hardness .....	29
3.3 Turning on the Machine .....	10	8.12 "INTENZA+" Water Filter .....	30
3.4 Warm-up and Rinsing .....	11	8.13 Adjusting the Coffee Grinder .....	32
3.5 Rinse/Self-Cleaning Cycle .....	11	8.14 Adjusting the "Aroma" - Amount of Ground Coffee .....	32
3.6 Eco-friendly: Stand-by .....	11	8.15 Adjusting Brewed Products .....	32
3.7 Adjusting the Dispensing Spout .....	12	<b>9 MACHINE PROGRAMMING</b> .....	<b>35</b>
3.8 Coffee Brewing .....	12	9.1 Programming Controls .....	35
3.8.1. Coffee with coffee beans .....	12	9.2 Beverage Menu .....	36
3.8.2. Coffee with pre-ground coffee .....	12	9.3 Machine Menu .....	38
3.9 Emptying the Coffee Grounds Drawer .....	14	9.4 "STEAM" Function Activation .....	42
3.10 Brewing a Cappuccino .....	14	9.5 "WARNING CLEANING" Function Activation .....	42
3.11 Latte Macchiato .....	15	<b>10 CLEANING AND MAINTENANCE</b> .....	<b>44</b>
3.12 "SPECIAL" Products .....	15	10.1 Cleaning Intervals .....	44
<b>4 ADJUSTING THE MACHINE</b> .....	<b>17</b>	10.2 Cleaning the Water Tank .....	44
<b>5 CLEANING AND MAINTENANCE</b> .....	<b>18</b>	10.3 Thorough Cleaning of the Cappuccinatore .....	44
5.1 Cleaning the Hot Water/Steam Wand .....	18	10.4 Brew Group Cleaning with the "Coffee Oil Remover System" .....	46
5.2 Cleaning the Coffee Grounds Drawer .....	18	10.5 Brew Group Lubrication .....	47
5.3 Cleaning the Drip Tray .....	18	10.6 Descaling .....	48
5.4 Cleaning the Cappuccinatore (After Each Use) .....	19	<b>11 MACHINE DISPOSAL</b> .....	<b>51</b>
5.5 Cleaning the Water Tank .....	20	<b>12 TROUBLESHOOTING</b> .....	<b>52</b>
5.6 Brew Group - Weekly Cleaning .....	20		
<b>6 MACHINE WARNINGS</b> .....	<b>23</b>		
			
<b>7 HANDLING AND STORAGE</b> .....	<b>25</b>		
7.1 Handling .....	25		
7.2 Storage .....	25		
<b>8 INSTALLATION</b> .....	<b>25</b>		
8.1 Safety Regulations .....	25		

## 1 GENERAL INFORMATION

### 1.1 Intended Use of the Machine

This machine automatically brews:

- Coffee and espresso coffee using coffee beans;
- Hot beverages using hot water dispensed via the dispensing spout;
- Milk-based beverages using the supplied Cappuccinatore.

The elegant machine housing has been designed for use in small offices, businesses and institutions.

 **Important.**  
Misuse voids all forms of warranty, releasing the Manufacturer from any responsibility for damage to property or personal injury.

The following are considered misuse:

- any use other than the intended use and/or employing methods other than those described in this manual;
- any operation on the machine in breach of the instructions provided in this manual;
- any use following tampering with machine components and/or alteration of its safety mechanisms;
- use of the machine outdoors.

In such cases the user shall bear the costs of repair.

### 1.2 How to Read the Manual

Various kinds of warning signs are used in this manual to highlight the different hazard or competence levels.



The warning triangle indicates important instructions for the safety of the machine's users.

Carefully follow these instructions to avoid serious injury!

Various warning signs are used in this manual to indicate the competences of each user.

**User:**  A person who uses the machine to brew beverages and who can clean the machine, where instructed to do so in the manual. Users are NOT allowed to perform operations which are the competence of the Service Provider/Supply Operator or Technician. On detecting machine failures and/or faults, users should contact the Service Provider only.

**Service Provider/Supply Operator:**



Company or person responsible for normal machine installation, start-up and suspension of service. On detecting machine failures, the Service Provider should request the assistance of the maintenance technician.

**Technician:** Personnel qualified to perform unscheduled maintenance and to service the machine.



Technicians may carry out all operations described in this manual without requiring explicit authorization.

 This warning sign is used to highlight information that is particularly important in order to guarantee the best performance of the machine.

### 1.3 How to Use these Operating Instructions

 This manual constitutes an integral part of the machine and should be read carefully. It contains information regarding installation, maintenance and proper use of the machine.

Always refer to this manual before any operation.

Keep these operating instructions in a safe place and make them available to anyone who may use the coffee machine. If this manual is lost or damaged, a copy should be requested from the service provider immediately. For further information or if you experience problems not completely or sufficiently covered in these instructions, please contact the service provider.

### 1.4 Machine Identification

The machine is identified by the model name and serial number shown on the special plate.

The plate contains the following information:

- Name of the Manufacturer
- CE marking
- Machine model
- Serial number
- Year of manufacture
- Some technical specifications:
  - Power supply voltage (V);
  - Power supply frequency (Hz);
  - Electrical power consumption (W).

 **Note:** When contacting the Service Provider, always refer to this plate, and to the machine's specific data shown on it.

## 1.5 Technical Specifications

Technical Specifications
<b>Power Supply and Nominal Voltage-Power Rating</b> See plate attached to the back of the appliance
<b>Machine Housing Material</b> Metal - Thermoplastic Material
<b>Size (w x h x d)</b> 336 x 380 x 450 (mm)
<b>Weight</b> 15 kg (approx.)
<b>Power Cord Length</b> 1.2 m
<b>Water Tank Capacity</b> 2.2 litres
<b>Coffee Grounds Drawer Capacity</b> 19 grounds
<b>Control Panel</b> On the front
<b>A-weighted Sound Pressure Level</b> Less than 70 dB
<b>Pump Pressure</b> Max. 1.5 MPa (15.0 bar)
<b>Operating Conditions</b> Minimum temperature: above 10°C Maximum temperature: below 40°C Maximum humidity: below 95%
<b>Safety Devices</b> Boiler pressure safety valve Safety thermostat

Subject to engineering and manufacturing changes due to technological improvements.

## 1.6 Residual Risks

The dispensing outlet has no guards to prevent accidental hand contact with coffee, hot beverages and/or steam.

## 2 MACHINE COMPONENTS

**i** Note: The "key to components" includes all machine models; check which one matches your machine. Certain functions may not be available.

- 1 Cup-warming surface
- 2 Water tank
- 3 Water tank lid
- 4 Cappuccinatore cover
- 5 Hot water wand
- 6 Coffee dispensing spout
- 7 Brew group
- 8 Service door
- 9 Coffee bean hopper lid
- 10 Coffee bean hopper
- 11 Pre-ground coffee compartment + lid
- 12 Cappuccinatore (removable type)
- 13 Coffee grounds drawer
- 14 Cup holder grill
- 15 Full drip tray indicator
- 16 Drip tray + (inner) tray cover
- 17 Power cord socket
- 18 Suction tube for Cappuccinatore
- 19 Pre-ground coffee selection button
- 20 "Espresso" button
- 21 "Brew" button
- 22 "Special Beverages" button
- 23 Display
- 24 "Cappuccinatore Cleaning Cycle" button
- 25 "Cappuccino" button
- 26 "Latte Macchiato" button
- 27 "Stand-by" button



## 2.1 Control Panel Description

**i** Note: All possible controls are described here. Refer to the following sections for the operating modes.

**i** Some buttons on the control panel have a double function. The double function is only activated in certain moments during the machine operation or when accessing the programming mode. The additional function is indicated by the icon under the machine button.

Button - Description
<b>19 "Pre-ground coffee" button</b> Use this button to select the coffee brew mode with pre-ground coffee.
<b>20 "Espresso" button</b> When this button is pressed an espresso coffee is brewed.
<b>21 "Brew" button - 2<sup>nd</sup> Function (OK)</b> When this button is pressed a cup of coffee is brewed. <b>2<sup>nd</sup> Function</b> - Press to select the displayed option.
<b>22 "Special Beverages" button - 2<sup>nd</sup> Function (ESC)</b> When this button is pressed, the menu for preparing other types of beverages is accessed. <b>2<sup>nd</sup> Function</b> - Press to exit the selected page and/or to stop the beverage brewing procedure.
<b>23 LCD Display</b> Displays the machine status and alarm signals, and guides the user through the steps required to operate the machine.
<b>24 "Clean" button - 2<sup>nd</sup> Function (▲)</b> When this button is pressed, the machine starts an automatic quick cleaning cycle of the Cappuccinatore. <b>2<sup>nd</sup> Function</b> - Press to scroll up the current page selection.
<b>25 "Cappuccino" button - 2<sup>nd</sup> Function (▼)</b> When this button is pressed a cappuccino is brewed. <b>2<sup>nd</sup> Function</b> - Press to scroll down the current page selection.
<b>26 "Latte Macchiato" button</b> When this button is pressed a latte macchiato is brewed.
<b>27 "Stand-by" button</b> When this button is pressed, the machine Stand-by mode is activated.

## 3 USING THE MACHINE

Before using the machine, check that the water tank and the coffee bean hopper are filled and that the machine is properly clean.

### 3.1 Filling the Water Tank

Before turning on the machine, the water tank should be filled with fresh drinking water.

**⚠ Warning!** Before using the machine for the first time, wash the water tank carefully. Fill the water tank with fresh drinking water only. Hot or carbonated water, as well as other liquids, will damage the machine.

**1** Remove the lid from the water tank.

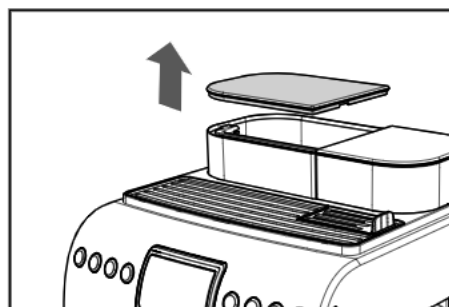

**2** Remove the tank; lift it using the inside handle.

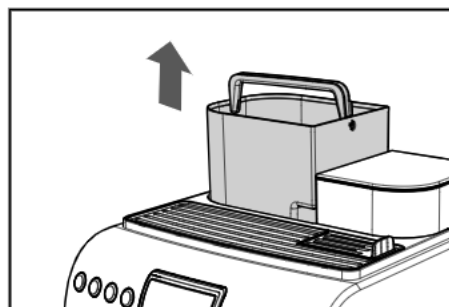

**3** Rinse and fill it with fresh water, making sure that the (MAX) level indicated in the tank is not exceeded.

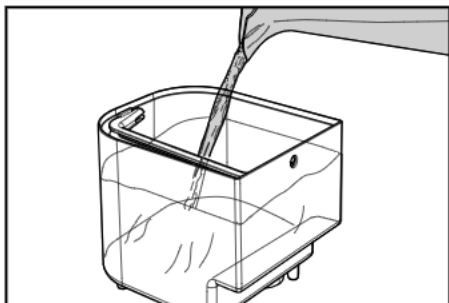

**4** Insert the water tank back into its seat and refit the lid.

### 3.2 Filling the Coffee Bean Hopper

Before turning on the machine, check that the hopper contains a sufficient quantity of coffee beans.

**!** Warning! Only coffee beans must be put into the coffee bean hopper. Ground coffee, instant coffee or any other object may damage the machine.

**1** Remove the coffee bean hopper lid.

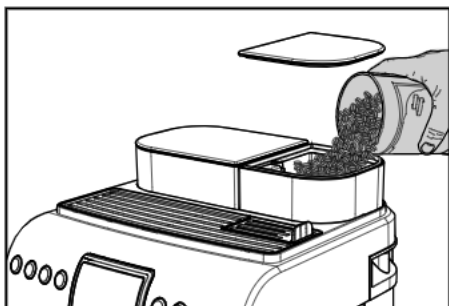

**i** Note: The hopper may feature a different safety system according to the regulations applicable in the country of use of the machine.

**2** Slowly pour the coffee beans into the hopper.

**i** If the water tank is not inserted, check that no coffee beans fall into the tank compartment. If this happens, remove them to avoid any malfunctions.

**3** Refit the coffee bean hopper lid.

### 3.3 Turning on the Machine

**!** Warning! Connection to the power supply should be carried out exclusively by the service provider!

Before turning on the machine, ensure that the plug is correctly inserted in the power socket.

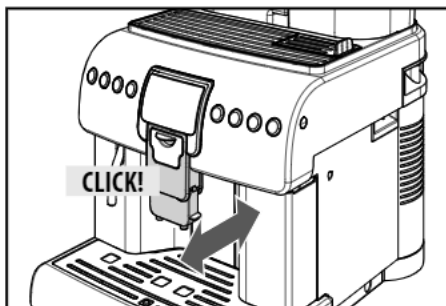

**i** Ensure that the dispensing spout is in the correct position. Move it horizontally until you hear the **CLICK!** indicating correct positioning. Otherwise, some product might leak out of the dispensing spout.

**1** To turn on the machine, move the power button on the back of the machine to "I" (Fig.02, page 3).

**2** After carrying out a check cycle, the machine goes into Stand-by mode and the "⏻" button (27) blinks.

**3** To turn on the machine simply press the "⏻" button (27).

**i** Note: Once the warm-up is complete, the machine performs a rinse cycle of the internal circuits. A small amount of water is dispensed during this process. Wait for this cycle to be completed.

### 3.4 Warm-up and Rinsing

**1** Upon start-up, the machine activates the warm-up phase. Wait until it is completed.

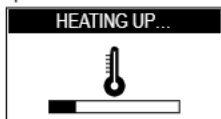

**i** Note: The progress bar indicates that the machine is warming up the system.

**2** Once the warm-up is complete, the machine performs a rinse cycle of the internal circuits.



**i** Note: The progress bar indicates that the machine is performing the rinse cycle of the system.

**3** A small amount of water is dispensed. Wait for the cycle to end.

**i** Note: The cycle can be stopped by pressing the "☺" button (22).

**4** Then, the machine is ready for use.

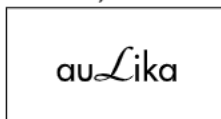

The logo is displayed indicating that the machine is ready for use.

**i** Note: If the machine is being used for the first time or after a long period of inactivity, contact the Service Provider to start it up.

### 3.5 Rinse/Self-Cleaning Cycle

This cycle allows the internal coffee circuits to be rinsed with fresh water. The cycle is carried out:

- At machine start-up (with cold boiler);
- After priming the circuit (with cold boiler);
- During the Stand-by preparation phase (if at least one coffee-based product has been brewed);

- When turning off the machine, after pressing the "☺" button (27) (if at least one coffee-based product has been brewed). The following icon will be displayed.



A small amount of water will be dispensed to rinse and heat all the machine parts; in this phase this icon is displayed.

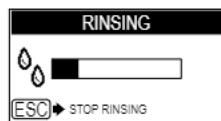

Wait for the cycle to finish automatically. The dispensing process can be stopped by pressing the "☺" button (22).

### 3.6 Eco-friendly: Stand-by

The machine is designed for energy saving. The machine automatically turns off after 30 minutes of inactivity.

**i** Note:

- During the turning off phase, the machine will perform a rinse cycle if a coffee product has been brewed.
- Time can be programmed according to your needs (contact the service provider).

To turn the machine on again, simply press a button on the control panel (if the power button is set to "I"). In this case the machine will go through the rinse cycle only if the boiler is cold.

### 3.7 Adjusting the Dispensing Spout

Most of the cups on the market can be used with this coffee machine.

The height of the dispensing spout may be adjusted to better fit the dimensions of the cups that you wish to use.

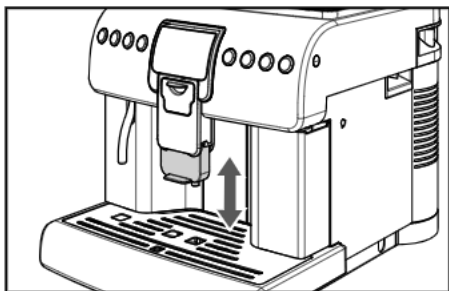

Manually move the dispensing spout up or down to adjust its height.

The recommended positions are:

- When using small cups (Fig.03, page 3);
- When using large cups (Fig.05, page 3).

Two cups can be placed under the dispensing spout to brew two cups of coffee at the same time (Fig.04, page 3).

If you want to use tall glasses or mugs, push the dispensing spout to its limit stop. In this case, you can only brew one product at a time (Fig.06, page 3).

**i** Note: Before brewing any product and/or when bringing the dispensing spout back to its normal brewing position, ensure that it is correctly positioned. This can be noted through the CLICK indicating correct positioning.

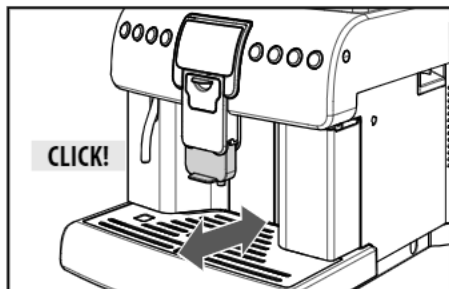

Otherwise, some product might leak out of the dispensing spout.

### 3.8 Coffee Brewing

#### 3.8.1. Coffee with coffee beans

To brew coffee, press and release:

- 1 the "☺" button (20) for a cup of espresso coffee; or the "☹" button (21) for a cup of coffee.

Then the brewing cycle starts:

Press the desired button once to brew 1 cup of coffee.

Press the desired button twice consecutively to brew 2 cups of coffee.

**i** Note: To brew 2 cups of coffee, the machine automatically grinds and doses the correct amount of coffee. Brewing two cups of coffee requires two grinding cycles and two brewing cycles, which the machine carries out automatically.

2 Once the prebrewing cycle is complete, coffee begins to come out of the dispensing spout.

3 Coffee dispensing stops automatically when the set level is reached. However, the coffee dispensing process can be stopped manually by pressing the "☹" button (22).

**i** Note: The machine is set to brew a true Italian espresso coffee. This feature may slightly lengthen the brewing time, allowing the intense coffee flavour to develop fully.

#### 3.8.2. Coffee with pre-ground coffee

This function allows pre-ground coffee to be used.

**i** Pre-ground coffee must be poured into the relevant compartment positioned next to the coffee bean hopper. Only use ground coffee for espresso machines and never coffee beans or instant coffee.

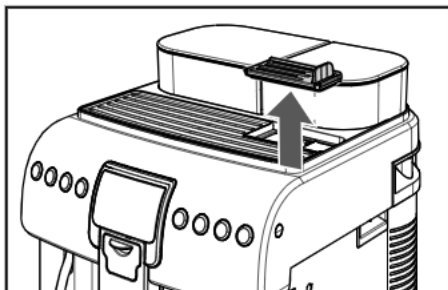

**i** Note: If no pre-ground coffee is poured into the compartment, only water will be dispensed; If the dose is excessive and 2 or more measuring scoops of coffee are used, the machine will not brew the product. Also in this case, the machine will run an empty cycle and discharge any ground coffee into the coffee grounds drawer.

To brew coffee:

**1** Press and release the "MENU" button (19) to select and activate the pre-ground coffee function.

This screen indicates that the function has been activated.

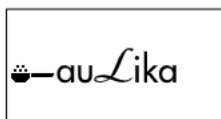

**i** Note: If the brewing is not started within 10 seconds, the machine goes back to the coffee beans operating mode and displays the coffee beans icon.

**2** Press and release:  
 the "ESPRESSO" button (20) for a cup of espresso coffee;  
 or  
 the "LONG ESPRESSO" button (21) for a long espresso coffee.

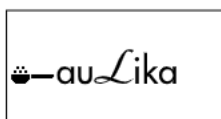

**i** Note: If the brewing is not started within 30 seconds after the screen is displayed or in case the

"STOP" button (22) is pressed, the machine returns to the main menu and discharges any inserted coffee into the coffee grounds drawer.

**3** Lift the pre-ground coffee compartment lid.

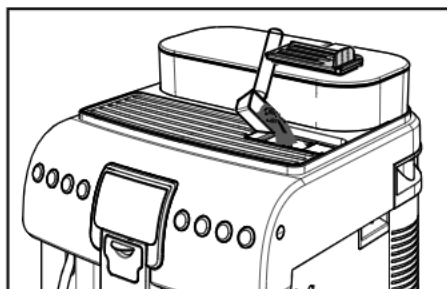

**!** Warning: Add only pre-ground coffee to the compartment. Other substances and objects may cause severe damage to the machine. Such damage will not be covered by warranty.

**4** Add only 1 scoop of pre-ground coffee to the compartment. Use only the measuring scoop supplied with the machine. Then, close the lid.

**5** Press the "ESPRESSO" button (21). Then the brewing cycle starts. Once the prebrewing cycle is complete, coffee begins to come out of the dispensing spout.

**6** Coffee dispensing stops automatically when the set level is reached. However, the coffee dispensing process can be stopped manually by pressing the "STOP" button (22). After brewing the product, the coffee beans configuration of the machine is restored.

**i** Note: Repeat the steps described above to brew other cups of coffee.

### 3.9 Emptying the Coffee Grounds Drawer

**i** Note: This operation must be performed with the machine turned on and/or in stand-by mode.

The machine will indicate when the coffee grounds drawer has reached its maximum capacity.

The first warning alerts the user that the coffee grounds drawer must be emptied, but the machine can still be used to brew coffee. The display will show:

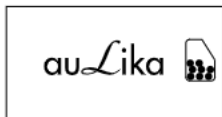

If the drawer is not emptied after several brewing cycles, the machine will stop and the display will show:



In this case the machine does not allow coffee to be brewed. In order to continue to brew coffee, the coffee grounds drawer must be emptied of used coffee.

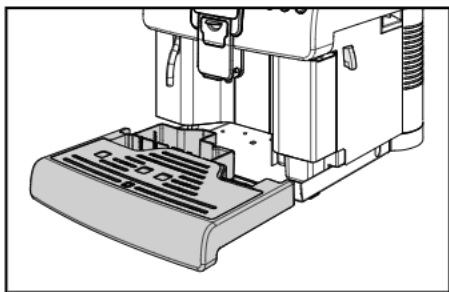

Remove the drip tray and empty it.

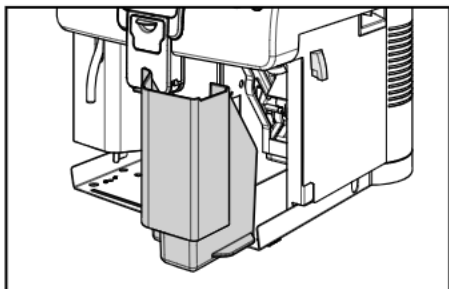

Remove the drawer and empty out the coffee grounds in a suitable container. Only when the display shows:

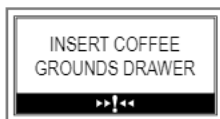

may the coffee grounds drawer be inserted into the machine. Having inserted the drawer, the display will show:

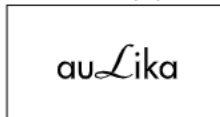

The machine is now ready to brew coffee.

### 3.10 Brewing a Cappuccino

The machine allows a cappuccino to be brewed quickly and easily with the touch of a button.

**!** Danger of scalding! Dispensing may be preceded by small jets of hot water.

**i** Important note: Clean the Cappuccinatore immediately after using it to froth milk (see section 5.4). Clean the suction hose externally with a damp cloth. This way, all parts will be perfectly clean and free of any milk residue. The service provider can activate a function to set a cleaning cycle 10 minutes after the last beverage was brewed, in the event that the cycle is not manually started by the user.

**1** Remove the cover from the front side (Fig.08, page 3).

**i** Note: The cover can be placed on the machine side using the integrated magnet.

**2** Insert the Cappuccinatore into its seat until it locks into place (Fig.09-10, page 3). Check that it cannot be pulled out.

**!** Warning: Before using the Cappuccinatore, clean it as described in section 5.4.

**3** Insert the clean pipe directly into the milk container (Fig.11, page 3).

**i** Note: To ensure better results when preparing a cappuccino, use cold milk.

**4** Place the cup under the dispensing spout (Fig.12, page 3). Press the "☕" button (25).

**5** The machine needs time to preheat.

**6** After preheating, the machine starts brewing the cappuccino.



**7** At this stage, the machine dispenses frothed milk. The dispensing process can be stopped by pressing the "☕" button (22).

**8** After dispensing milk, the machine brews coffee. The brewing process can be stopped by pressing the "☕" button (22).



Enjoy your cappuccino as if straight from the coffee shop.

**9** After using the Cappuccinatore, clean it as described in section 5.4.

**10** Remove the container and clean it if necessary.

### 3.11 Latte Macchiato

**i** Important note: Clean the Cappuccinatore immediately after using it to froth milk (see section 5.4). Clean the suction hose externally with a damp cloth. This way, all parts will be perfectly clean and free of any milk residue. The service provider can activate a function to set a cleaning cycle 10 minutes after the last beverage was brewed, in the event that the cycle is not manually started by the user.

The machine allows a cup of latte macchiato to be brewed quickly and easily with the touch of a button.

To dispense a cup of latte macchiato, perform all the steps described in section 3.10 up to step 3.

**1** We recommend using tall glasses for this type of preparation, thus moving the dispensing spout accordingly (Fig.13, page 3).

**2** When the machine is ready, press the "☕" button (26) to start brewing the latte macchiato.

**3** The machine prepares the latte macchiato automatically.

**i** Note: The milk and coffee brewing process can be stopped by pressing the "☕" button (22).

**4** After using the Cappuccinatore, clean it as described in section 5.4.

Remove the container and clean it if necessary.

### 3.12 "SPECIAL" Products

The machine is designed to also brew products other than those displayed on the control panel.

**i** Note: After pressing the "☕" button (22), if no product is selected, the machine goes back to the main menu after 10 seconds.

**1** Press the "☕" button (22) to access the menu.

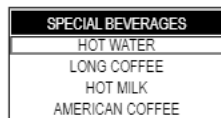

**i** Note: The "STEAM" function is displayed and can be selected only if it has been previously activated by the service provider; otherwise, it is not available.

**2** The display shows the page for "special" beverages.

**i** Note: This menu enables only a single brewing process at a time. To brew more products repeat the described procedures.

**3** Select the desired beverage by pressing the "SELECT" button (24) or the "OK" button (25).

**4** When the desired beverage has been selected, press the "OK" button (21) to start the preparation.

**i** Refer to the section describing the brewing procedure for the desired beverage.

**i** For the preparation of milk-based beverages, install the Cappuccinatore after washing it as described in section 5.4.

### Hot Water Dispensing

 Dispensing may be preceded by short spurts of hot water. Danger of scalding. The hot water wand may reach high temperatures.

**1** Press the "ESC" button (22) to access the menu.

SPECIAL BEVERAGES
HOT WATER
LONG COFFEE
HOT MILK
AMERICAN COFFEE

**2** Place a container under the hot water wand (Fig.07, page 3).

**3** Press the "OK" button (21) to start dispensing hot water through the wand.



**4** After dispensing, remove the container with hot water.

**i** Note: You can stop the brewing process by pressing the "ESC" button (22).

### Long Coffee

This programme allows you to prepare a long coffee.

**1** Press the "ESC" button (22) to access the menu.

**2** Press the "OK" button (25) to select "LONG COFFEE".

SPECIAL BEVERAGES
HOT WATER
LONG COFFEE
HOT MILK
AMERICAN COFFEE

**3** Place a suitable cup under the dispensing spout (Fig.05, page 3).

**4** Press the "OK" button (21) to start the preparation.

**5** After brewing, remove the coffee cup.

**i** Note: You can stop the brewing process by pressing the "ESC" button (22).

### Hot Milk

This programme allows you to prepare a hot milk.

 Danger of scalding! Dispensing may be preceded by small jets of hot water.

**1** Remove the cover from the front side (Fig.08, page 3).

**2** Insert the complete Cappuccinatore into its seat until it locks into place (Fig.09-10, page 3). Check that it cannot be pulled out.

**3** Insert the clean pipe directly into the milk container (Fig.11, page 3).

**i** Note: To ensure better results, use cold milk.

**4** Press the "ESC" button (22) to access the menu.

Press the "OK" button (25) to select "HOT MILK".

SPECIAL BEVERAGES
HOT WATER
LONG COFFEE
HOT MILK
AMERICAN COFFEE

**5** Place a suitable cup under the dispensing spout (Fig.13, page 3).

**6** Confirm by pressing the "OK" button (21) to start the preparation.



**i** Note: The brewing process can be stopped by pressing the "ESC" button (22).

**7** When the dispensing procedure is complete, remove the cup of milk.

**i** After using the Cappuccinatore, clean it as described in section 5.4. The service provider can activate a function to set a cleaning cycle 10 minutes after the last beverage was brewed, in the event that the cycle is not manually started by the user.

Remove the container and clean it if necessary.

### American Coffee

This programme allows you to prepare an American coffee.

**1** Press the "OK" button (22) to access the menu.

**2** Press the "AMERICAN COFFEE" button (25) to select "AMERICAN COFFEE".

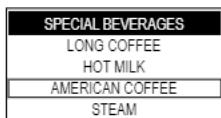

**3** Place a suitable cup under the dispensing spout (Fig.5, page 3).

**4** Confirm by pressing the "OK" button (21) to start the preparation.

**5** After brewing, remove the coffee cup.

**i** Note: You can stop the brewing process by pressing the "ESC" button (22).

### Steam

**i** Note: This function is only available if previously activated by the service provider.

**!** Dispensing may be preceded by short spurts of hot water. Danger of scalding. The steam wand may reach high temperatures. Only touch the wand by its handle.

This program allows steam to be dispensed in order to heat the beverages directly in the container.

**1** Press the "OK" button (22) to access the menu.

**2** Press the "STEAM" button (25) to select "STEAM".

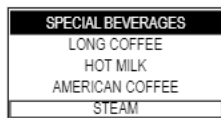

**3** Place a suitable container under the dispensing spout (Fig.7, page 3).

**4** Press the "OK" button (21) to confirm.

**5** The machine heats up the system. Once the required temperature is reached, the steam dispensing procedure is started.



**6** To stop the steam dispensing process, press the "ESC" button (22).

Clean the steam wand with a wet cloth after use, if necessary.

## 4 ADJUSTING THE MACHINE

The machine allows numerous adjustments to be made directly by the user.

It is recommended to apply the settings defined by the service provider or to agree all settings with him/her to ensure normal machine use.

Any inappropriate adjustments made could reduce the quality of the brewed product.

## 5 CLEANING AND MAINTENANCE

As some of the parts of the appliance come in contact with water and coffee during normal use, it is important to clean the appliance regularly.

Neglecting to regularly clean the appliance will ultimately cause it to stop working properly, and in this case repair is not covered under warranty.

**Warning.** Before undertaking any maintenance and/or cleaning operation, turn off the machine, unplug it and wait for it to cool down.

Non-removable parts and the machine itself must be cleaned, when not otherwise specified, using only cold or lukewarm water, with a non-abrasive sponge and a damp cloth.

- Cleaning can only be carried out when the machine is cold and unplugged.
- Use a soft, damp cloth to clean the machine.
- Do not use direct jets of water.
- Do not immerse the machine in water or place any of its parts in a dishwasher.
- Do not use sharp objects or harsh chemical products (solvents) for cleaning.
- Do not dry the machine and/or its parts using a microwave and/or standard oven.
- All parts requiring cleaning are easily accessible, so no tools are needed.
- Periodic maintenance and cleaning will keep the machine in good working order for a longer time and ensure compliance with basic hygienic standards.

**Warning.** The machine and its parts should in any case be cleaned every week.

**i** The appliance and its parts should be cleaned and washed following a period of inactivity.

### 5.1 Cleaning the Hot Water/Steam Wand

The hot water/steam wand must be cleaned externally with a damp cloth after each use and, in any case, once a week.

**Warning.** Before performing this operation, make sure that the wand is cold: Danger of burns!

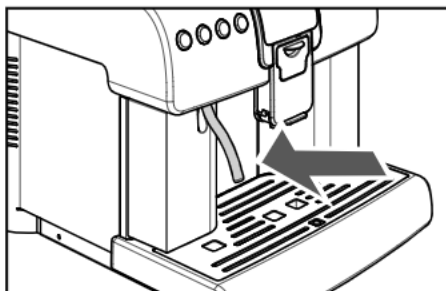

### 5.2 Cleaning the Coffee Grounds Drawer

The coffee grounds drawer is to be emptied and cleaned whenever indicated by the machine. To carry out this operation, refer to section 3.9.

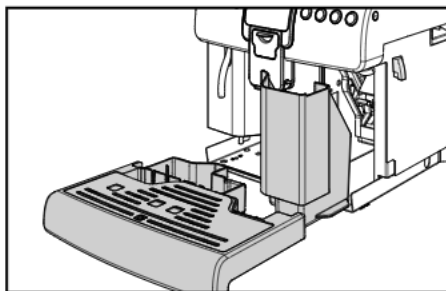

### 5.3 Cleaning the Drip Tray

Empty and clean the drip tray every day. Perform this operation also when the float is raised.

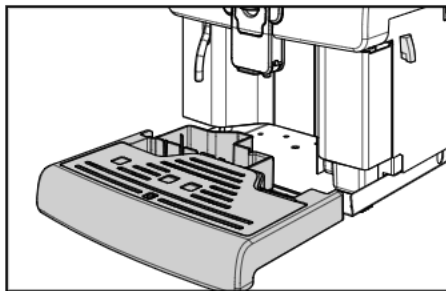

### 5.4 Cleaning the Cappuccinatore (After Each Use)

**Warning!** Failure to clean the Cappuccinatore after use with milk may cause proliferation of bacteria which may be harmful for the user.

The Cappuccinatore must be washed and cleaned every time it is used. The lack of cleaning before and after each use can affect the correct operation of the machine.

**Danger of scalding!** Dispensing may be preceded by small jets of hot water.

Perform a quick cleaning procedure as follows:

**1** Ensure that the Cappuccinatore, complete with all its parts, is correctly inserted (Fig.10, page 3).

**2** Insert the suction hose in a carafe containing clean water (Fig.11, page 3).

**3** Place a container under the dispensing spout (Fig.12, page 3).

**4** With the machine on, press the "Clean" button (24).

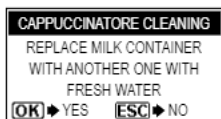

**5** Press the "OK" button (21) to start the Cappuccinatore cleaning cycle.

**i** Note: To exit the cycle at any moment, press the "ESC" button (22).

**6** The machine warms up the system.

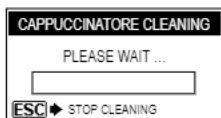

Once the warm-up is complete, the machine performs an assisted wash cycle of the Cappuccinatore. Wait until the cycle is complete.

**7** Only once the cycle is complete, press the side buttons and remove the Cappuccinatore.

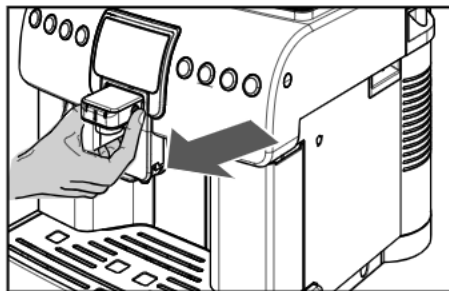

**8** Place the cover back on the machine (Fig.08, page 3).

**i** Important note: It is advisable to remove the Cappuccinatore from the machine when not being used, in order to keep it clean.

**9** Remove the suction tube from the Cappuccinatore.

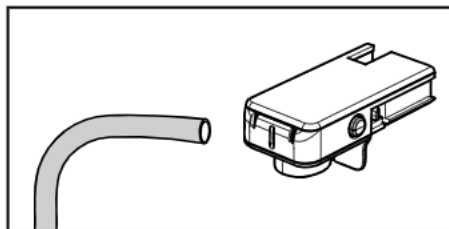

**10** Remove the ring from the Cappuccinatore.

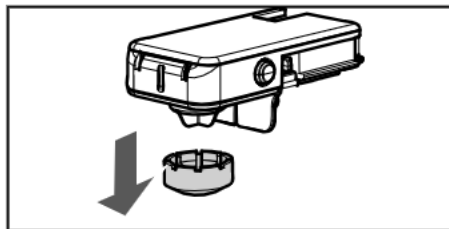

**11** Turn and lift the Cappuccinatore cover and remove it from the Cappuccinatore body.

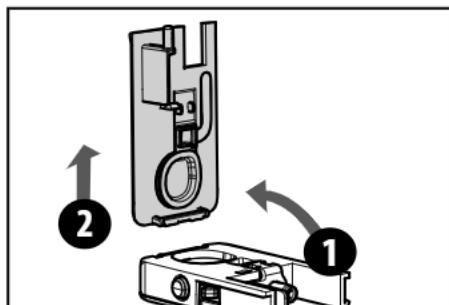

**12** Remove the valve from the Cappuccinatore.

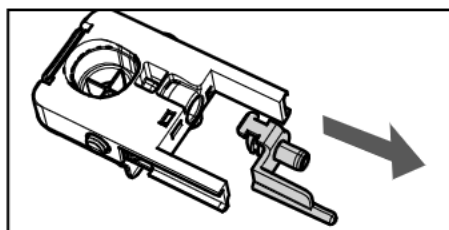

**13** Remove the suction tube joint from the Cappuccinatore.

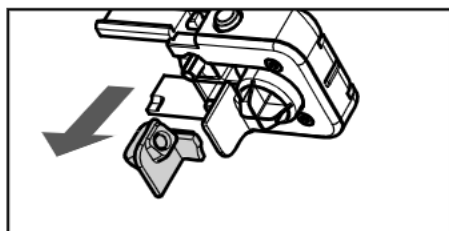

**14** Wash the parts under running water.  
Make sure any milk deposits/residues are removed.

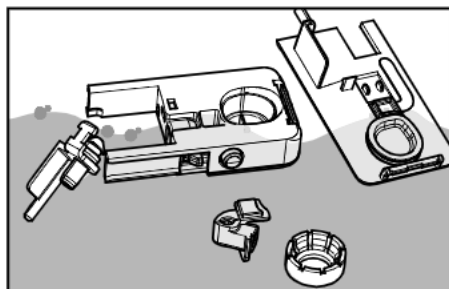

**15** After washing, reassemble the parts following the same procedure used for disassembly, but in reverse order.

**i** Important note: After washing and reassembling the Cappuccinatore, it can be installed back in the machine. Use the hooks placed on the left side of the machine to attach the suction tube.

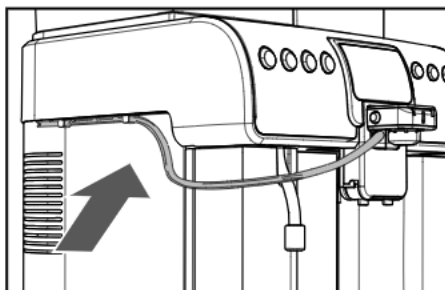

### 5.5 Cleaning the Water Tank

It is recommended to clean the water tank daily:

- Remove the "INTENZA+" water filter from the water tank (or remove the small white filter if you have not yet installed the "INTENZA+" water filter) and then wash it under running drinking water;
- Reposition the "INTENZA+" water filter (or the small white filter if you have not yet installed the "INTENZA+" water filter) in its housing by gently pressing and turning it at the same time;
- Fill the water tank with fresh drinking water.

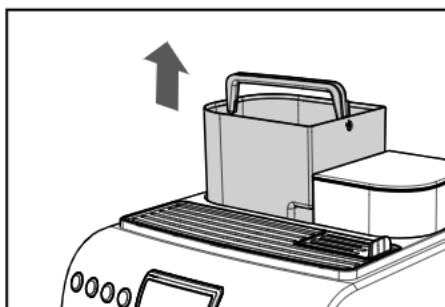

### 5.6 Brew Group - Weekly Cleaning

The Brew Group should be cleaned whenever the coffee bean hopper is filled, or at least once a week.

**1** Turn off the machine by pressing the power button and remove the plug from the socket.

**2** Remove the drip tray and the coffee grounds drawer.

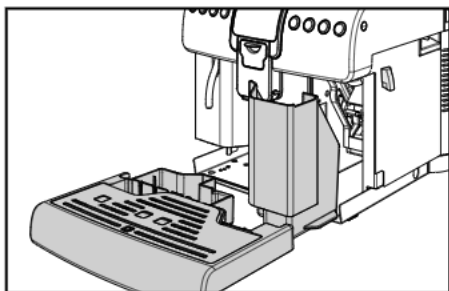

**3** Open the service door with the supplied key.

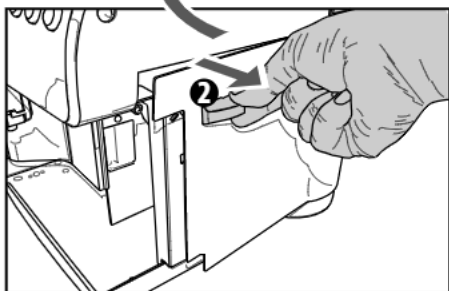

**4** Remove the Brew Group: pull it by the handle and press the "PRESS" button. The Brew Group must be washed with lukewarm water only. Do not use detergent.

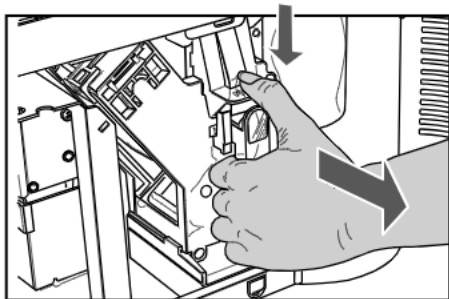

**5** Wash the Brew Group with lukewarm water and carefully wash the upper filter. Before placing the Brew Group in its seat, ensure that there is no water left in the brewing chamber.

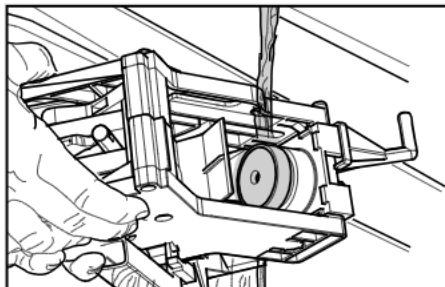

**6** Lift the rear side of the inner drawer to unlock it.

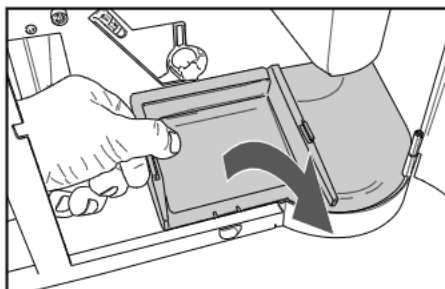

**7** Remove the inner drawer, wash it and put it back into its seat.

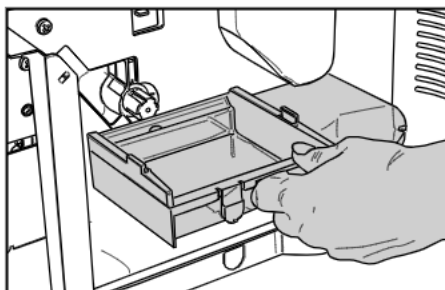

**i** Note: When refitting the drawer, carry out the same operations performed for its removal, but in reverse order.

**8** Ensure that the Brew Group is in the rest position; the two reference marks must match.

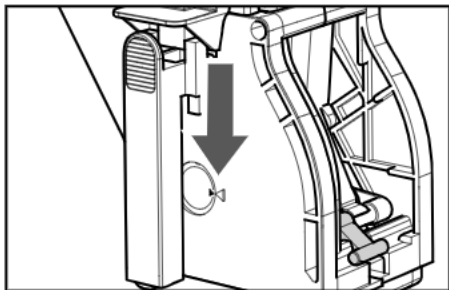

If they do not match, proceed as described in step (9).

**9** Ensure that the lever is in contact with the brew group base.

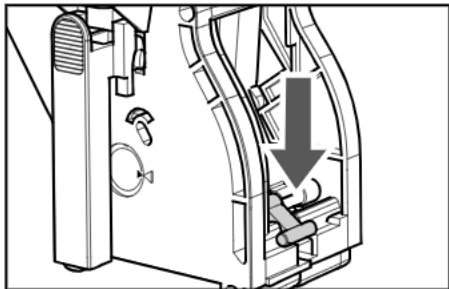

**10** Ensure that the hook to lock the Brew Group is in the correct position; to do that, press the "PRESS" button firmly.

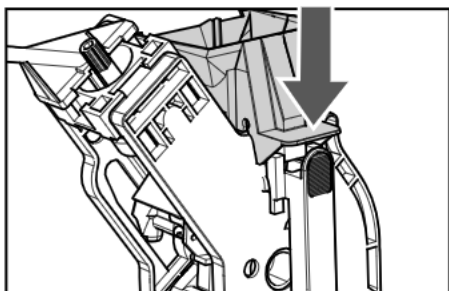

**11** Insert the Brew Group back into its seat until it locks into place, WITHOUT pressing the "PRESS" button.

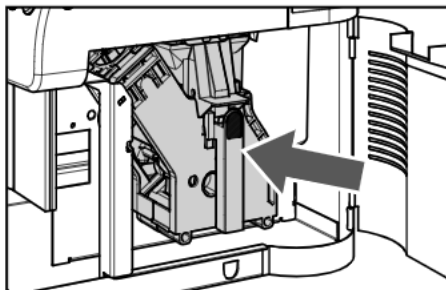



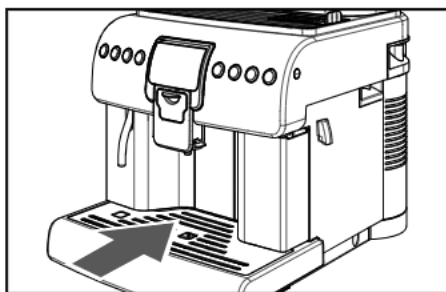







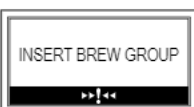

**12** Insert the coffee grounds drawer and the drip tray. Close the service door.



**6 MACHINE WARNINGS**

This chapter describes all the warning messages that the machine may display to the user, and the actions that can and/or must be performed by the user.

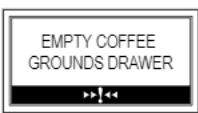
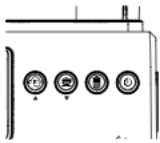
Help Message Displayed	How to Reset the Message
	To restore the machine operation, close the service door.
	Place the drip tray in its seat (Ref.16 - Page 2).
	Place the coffee grounds drawer in its seat (Ref.13 - Page 2).
	Close or correctly place the coffee bean hopper inner lid to be able to brew any product.
	Remove the tank and fill it with fresh drinking water.
	Insert the Brew Group into its seat.
	The selected operation requires milk dispensing. Insert the Cappuccinatore in the machine as specified in the manual.
	The selected operation requires milk dispensing. Insert the previously removed valve in the Cappuccinatore as described in the manual (see step 12 - section 5.4).
	Fill the coffee bean hopper with coffee beans.

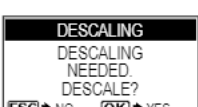
Help Message Displayed	How to Reset the Message
	<p>The machine requires a descaling cycle. When this message is displayed, it is still possible to use the machine, but its correct operation might be affected. Damage caused by failure to descale the machine is not covered by warranty.</p>
	<p>The machine indicates that the "Intenza" water filter should be replaced with a new one. Contact the service provider.</p>
	<p>The machine indicates that after a few cycles it will be necessary to empty the coffee grounds drawer (see section 3.9). This message does not prevent the machine from brewing further products.</p>
	<p>Remove the coffee grounds drawer and empty the coffee grounds into a suitable container. <b>Note: The coffee grounds drawer must be emptied only when indicated by the machine and with the machine turned on and/or in stand-by mode. If the drawer is emptied with the machine turned off, the machine will not record the emptying operation.</b></p>
	<p>Blinking red light. Machine in Stand-by.  The Stand-by settings can be changed (contact the service provider).  Press the "⏻" button (27).</p>
	<p>An event has occurred which requires the machine to be restarted. Take note of the code (E xx) shown at the bottom. Turn off the machine, wait for 30 seconds and then turn it on again. If the problem persists, contact the service centre.</p>
	<p>If this screen is displayed after starting the machine, a descaling cycle should be run. Contact the service provider. <b>Please note that damage caused by failure to descale the machine is not covered by warranty.</b></p>



## 7 HANDLING AND STORAGE



All the operations described in chapter 7 must be performed exclusively by the service provider or a specialised technician, who shall organise all the operating steps and use only suitable means to ensure strict compliance with the safety regulations in force.

### 7.1 Handling

During handling and transportation, the machine must be kept in an upright position, according to the instructions printed on the packaging. Care should be taken during lifting and positioning. Do not shake the machine.



**Make sure that nobody is standing in the area during load lifting and handling. In difficult conditions, assign suitable personnel to monitor all movements.**

### 7.2 Storage

The machine should be stored in accordance with the following conditions:

- Minimum temperature: above 4°C;
- Maximum temperature: below 40°C;
- Maximum humidity: below 95%.

The machine is packed in cardboard and expanded polystyrene packaging.



**Warning. Due to the total weight of the packaged product, do not stack more than three machines on top of each other. The machine should be stored in its original packaging, in a dry and/or dust-FREE place.**

## 8 INSTALLATION



All the operations described in chapter 8 must be performed exclusively by the service provider or a specialised technician, who shall organise all the operating steps and use only suitable means to ensure strict compliance with the safety regulations in force.

### 8.1 Safety Regulations

- Read the entire instruction manual carefully.
- The machine should be connected to the mains according to the safety regulations in force in the country where the machine is used.
- Connection to the drinking water network (for water-network supplied machines) should be made in compliance with the safety regulations in force in the country where the machine is to be used.
- The socket to which the machine is connected should be:
  - compatible with the type of plug installed on the machine;
  - suitably sized to comply with the data on the plate attached to the bottom of the appliance;
  - connected to an efficient earthing system.
- The power cord should not:
  - come into contact with any type of liquid: danger of electric shocks and/or fire;
  - be crushed and/or come into contact with sharp surfaces;
  - be used to move the machine;
  - be used if damaged;
  - be handled with damp or wet hands;
  - be wound in a coil when the machine is in use;
  - be tampered with.
- If the power cord is damaged, it must be replaced by the manufacturer or an authorised service centre, or in any case by a person with a similar qualification.
- It is forbidden to:
  - Install the machine other than as described in Chapter 8, or outdoors.
  - Install the machine in a location where water jets may be used.
  - Disable the safety features installed by the manufacturer.
  - Use the machine close to flammable and/or explosive materials.
  - Leave plastic bags, polystyrene, nails, etc., within the reach of children, as they are potential hazards.
  - Allow children to play near the machine.
  - Use spare parts other than those recommended by the manufacturer.

- Make any technical modifications to the machine.
- Immerse the machine in any kind of liquid.
- Wash the machine using a jet of water.
- Use the machine in any manner other than as described in this manual.
- Install the machine on top of other appliances.
- Use the machine in explosive or harsh environments, or with high concentrations of dust or oily substances suspended in the air.
- Use the machine in an environment in which a risk of fire exists.
- Use the machine to dispense products other than those it is designed for.
- Before cleaning the machine, ensure the plug is disconnected from the power socket; do not wash it with fuel and/or solvents of any kind.
- Do not place the machine near heating equipment (such as heaters or radiators).
- In case of fire, use carbon dioxide (CO<sub>2</sub>) extinguishers. Do not use water or dry powder extinguishers.

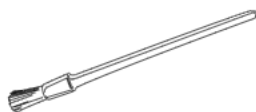

**Cleaning brush:** to remove the coffee grounds from the service compartment.



**Lubricating oil:** to lubricate the Brew Group at periodic intervals (see section 10.5).



**Descaling solution:** to remove limescale build-up in the water circuit caused by normal use.

## 8.2 Stop Functions

The machine can be stopped by means of the power button.

## 8.3 List of Accessories

### 8.3.1 List of Accessories Supplied

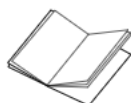

**Manual:** instructions on how to use the machine.



**Power cord:** to connect the machine to the mains.

### 8.3.2 List of Optional Accessories



**Water hardness test:** quick test to determine the actual hardness of the water used to prepare beverages; this test is of fundamental importance to set the water hardness in the machine.



**"Intenza +" water filter:** to remove any unpleasant flavours in the water and reduce water hardness. This will improve machine use.

**8.4 Assembly-Siting**

**!** The machine should not be installed outdoors or in environments in which jets of water or steam are used.

**!** The presence of magnetic fields or proximity to electrical machines which generate interference could cause the electronic controls of the machine to malfunction. At temperatures close to 0°C, internal parts containing water are at risk of freezing. Do not use the machine under these conditions.

To ensure correct and efficient performance of the appliance, comply with the following recommendations:

- Room temperature: 10°C - 40°C;
- Maximum humidity: 90%.
- the site should be suitably prepared for the installation of the machine;
- the surface on which the machine is installed should be level, solid and stable, with a gradient of max. 2°;
- the location should be adequately lit, ventilated and clean, and the power socket should be easily accessible.

**!** Access to the machine and the plug should be kept clear at all times, in order to allow users to easily reach them and to leave the area immediately if required.

The following illustration shows the required access distances:

- to the keypad on the front of the appliance;
- to the service units in the event of malfunction.

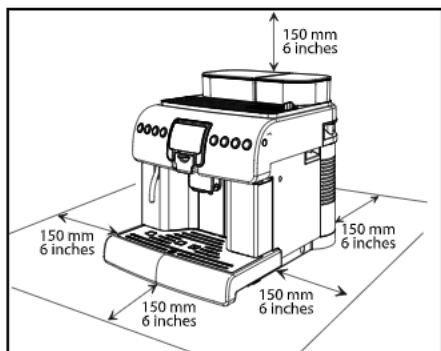

After placing the packaged product near the installation site, proceed as follows:

- ensure that the packaging has not been tampered with during transport and that the original packaging is intact and closed;

- open the packaging;
- check the condition and model of the machine;
- check the contents of the accessories bag enclosed with the machine (see "8.3.1 List of Accessories Supplied");
- remove the machine from its original packaging;
- remove any remaining packaging from the machine;
- lift the machine and place it in the designated area.

**8.5 Disposal of Packaging**

After opening the outer box, it is recommended that the packaging materials are separated according to type and disposed of in accordance with the regulations in force in the country of use.

**i** We recommend keeping the outer box for future transfers or transportation.

**8.6 Filling the Water Tank**

Before turning on the machine, the water tank should be filled with fresh drinking water.

**!** **Warning!** Before using the machine for the first time, wash the water tank carefully. Fill the water tank with fresh drinking water only. Hot or carbonated water, as well as other liquids, will damage the machine.

Refer to section 3.1. to carry out the procedure correctly.

**8.7 Filling the Coffee Bean Hopper**

Before turning on the machine, check that the hopper contains a sufficient quantity of coffee beans.

**!** **Warning!** Only coffee beans must be put into the coffee bean hopper. Ground coffee, instant coffee or any other object may damage the machine.

Refer to section 3.2. to carry out the procedure correctly.

**8.8 Electrical Connection**

**!** This operation must only be performed by specialised technical personnel or by the service provider.

The machine is designed to work with single-phase voltage matching the rating indicated on the identification plate (section 1.4 "Machine Identification").

Before plugging in the machine, make sure that the power button

is switched to "0".

The Service Provider makes and is responsible for the electrical connection of the machine.

The machine should be connected to the mains using the plug installed on the power cord, in accordance with:

- The Laws and Regulations in force at the place and time of installation;
- The information shown on the technical specifications plate on the side of the machine.

**Warning:** The electric socket which the appliance is connected to should be easily accessible by the user, in order to allow it to be easily disconnected from the mains when necessary.

**It is forbidden to:**

- Use extensions of any kind.
- Replace the original plug.
- Use adapters.

### 8.9 Setting the Language (Upon First Use)

At first start up, the desired language for the display of messages must be selected and stored. This allows the beverage parameters to be adjusted to the specific taste of the country where the machine is in use.

LANGUAGE
ITALIANO
ENGLISH
DEUTSCH
FRANÇAIS

**1** Select the language by pressing the "MENU" button (24) or "☺" button (25).

**2** Press the "☺" button (21) to store the language.

**3** The machine starts the system warm-up.

**i** **Note:** Upon first use, once the warm-up is complete the machine primes the circuit and performs a rinse cycle of the internal circuits. During this process, a small amount of water is dispensed. Wait for this cycle to be completed.

### 8.10 First Use - Use After a Long Period of Inactivity

**For a perfect Espresso: Rinse the coffee circuit if using the machine for the first time or after a long period of inactivity.**

These simple operations will allow you to always brew excellent coffee. They have to be performed:

- A) At first start-up;
- B) When the machine remains inactive for a long time (more than 2 weeks).

**1** (Fig.5, page 3) Place a large container under the dispensing spout.

**2** Empty the water tank, wash and rinse it and fill it with fresh water.

**3** Select the pre-ground coffee brewing function by pressing the "☺" button (19) once.

The display indicates that the pre-ground function has been selected.

**4** Press the "☺" button (21) to select the coffee.

**i** **Note:** Do not add pre-ground coffee to the compartment.

**5** Press the "☺" button (21) to start the brewing procedure. The machine will dispense hot water through the dispensing spout. Wait until the dispensing procedure is complete and empty the water tank.

**6** Repeat the operations from step 1 to step 5 three times, then continue with step 7.

**7** (Fig.7, page 3) Place a container under the hot water wand.

**8** Press the "☺" button (22) and the "☺" button (21) to select and start dispensing HOT WATER.

**9** When the hot water dispensing procedure is complete, empty the container.

**10** The machine is now ready for use.

**8.11 Measuring and Adjusting Water Hardness**

Measuring water hardness is very important in order to correctly manage the "INTENZA+" filter and the frequency with which the machine must be descaled.

**1** Immerse the water hardness test strip in water for 1 second.

**i** **Note:** The test strip is only valid for one measurement.

**2** Check how many squares change colour and refer to the table.

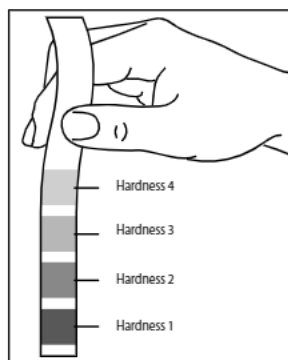

**3** The numbers correspond to the settings indicated in the following machine adjustments.

HARDNESS 4 (hard)  
 HARDNESS 3 (medium)  
 HARDNESS 2 (soft)  
 HARDNESS 1 (very soft)

**4** Switch to programming mode as described in chapter 9.

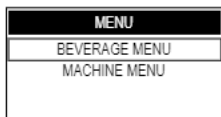

**5** To select the "MACHINE MENU" option, press the "OK" button (25).

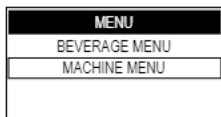

**6** Press the "OK" button (21) to access.

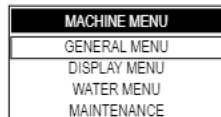

**7** Press the "OK" button (25) until the "WATER MENU" option can be selected.

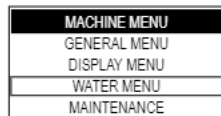

**8** Press the "OK" button (21) to access.

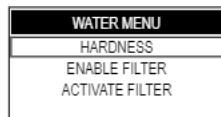

**9** Press the "OK" button (21) to access the "HARDNESS" menu.

**i** **Note:** The machine is supplied with standard adjustments, suitable for most uses.

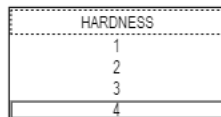

**10** Press:  
 the "UP" button (25) to increase the value  
 or  
 the "DOWN" button (24) to decrease the value.

**11** Press the "OK" button (21) to confirm the selected change.

After adjusting water hardness, install the filter (Intenza+), as described in the following section. Exit programming mode as described in section 9.1.

## 8.12 "INTENZA+" Water Filter

Water is a key element for a good espresso coffee. It should therefore always be filtered in a professional manner. That is why all Saeco machines can be equipped with the INTENZA+ filter. This filter is easy to use and its sophisticated technology is effective in preventing limescale build-up. This way, water will always be perfect and will give a much more intense aroma to your espresso coffee.

**i** The "INTENZA+" water filter can be installed only if the machine is NOT connected to the water network.

**!** The descaling filter should be replaced whenever indicated by the machine. Before descaling, remove the anti-scale filter from the water tank.

**i** Measuring water hardness is very important in order to correctly manage the "INTENZA+" water filter and the frequency with which the machine must be descaled.

**1** Remove the "INTENZA+" water filter from its packaging. The filter should be set according to the measurements performed to set water hardness.

Use the water hardness test strip provided with the machine. Set the "Intenza Aroma System" as specified on the filter packaging (see section 8.11).

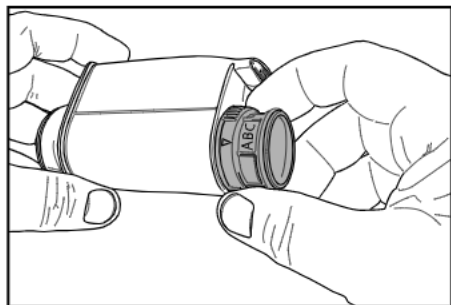

- A = Soft water
- B = Hard water (standard)
- C = Very hard water

**2** Immerse the "INTENZA+" water filter vertically in cold water (with its opening positioned upwards) and delicately press its sides so as to let the air bubbles out.



**3** Switch to programming mode as described in chapter 9.

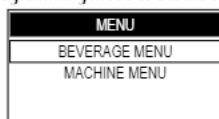

**4** To select the "MACHINE MENU" option, press the  button (25).

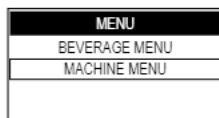

**5** Press the  button (21) to access.

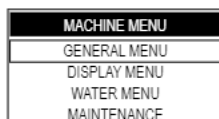

**6** Press the  button (25) until the "WATER MENU" option can be selected.

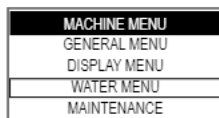

**7** Press the  button (21) to access.

**8** Press the  button (25) until the "ACTIVATE FILTER" option can be selected.

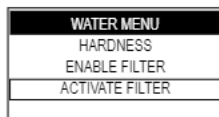

**9** Press the "OK" button (21) to access.



**i** Note: To exit the procedure, press the "OK" button (22).

**10** Press the "OK" button (21) to continue.



**11** Remove the tank from the machine and empty it. Remove the small white filter from the tank and store it in a dry place sheltered from dust.

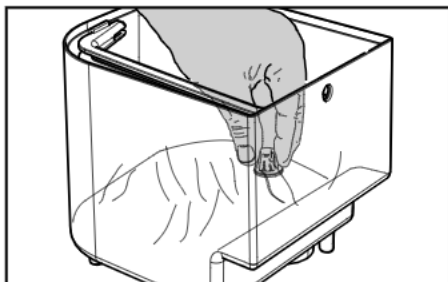

**12** Put the filter into the empty tank. Press it to its limit stop.

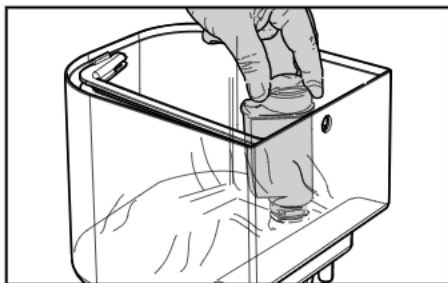

**13** Fill the tank with fresh drinking water and reinsert it into the machine.

**14** Press the "OK" button (21) to confirm the introduction of the new filter.

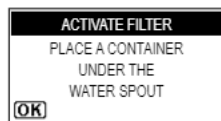

**15** Place a large container under the hot water wand (Fig.07, page 3).

**16** Press the "OK" button (21) to confirm.

Wait until the machine stops dispensing the necessary water to activate the filter.

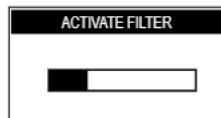

At the end of the cycle, remove the container previously placed under the hot water wand.

**i** Note: At the end of the procedure, the display automatically returns to the product brewing screen. If the water filter is not available, insert the small white filter previously removed (see step 11) into the tank.

### 8.13 Adjusting the Coffee Grinder

**Warning!** Do not pour ground and/or instant coffee into the coffee bean hopper. Do not put any material other than coffee beans into the hopper. The coffee grinder contains moving parts that may be dangerous. Do not insert fingers and/or other objects. Turn off the machine by pressing the ON/OFF button and remove the plug from the socket before carrying out any type of operation inside the coffee bean hopper.

The machine allows the coffee grind to be slightly adjusted in order to adapt it to the kind of coffee used. To make any adjustment, use the lever located on the side of the machine.

Turn the lever by only one notch at a time during the grinding phase. Brew 2-3 cups of coffee to verify changes in grind.

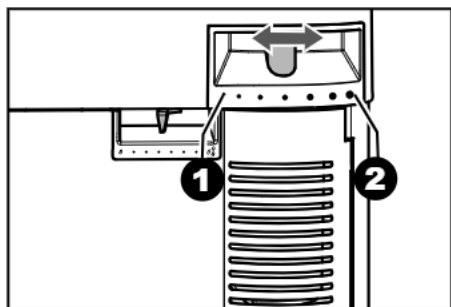

The reference marks indicate the grind setting. You can set different degrees of grind with the following references:

- 1 - Fine Grind
- 2 - Coarse Grind

### 8.14 Adjusting the "Aroma" - Amount of Ground Coffee

The machine allows the amount of coffee to be ground for preparing each cup of coffee to be programmed.

**Warning!** The Aroma adjustment lever must only be turned when the coffee grinder is stopped. Adjustment must be performed before brewing coffee.

To make any adjustment, use the lever located on the side of the machine.

The reference marks indicate the amount of ground coffee which has been set. You can set different amounts with the following references:

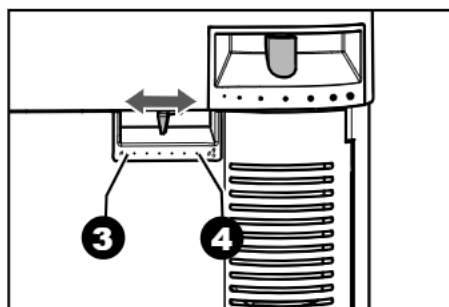

3 - Minimum coffee amount (about 7 grams)

4 - Maximum coffee amount (about 11 grams)

### 8.15 Adjusting Brewed Products

The machine allows you to adjust the product length according to your needs and to the type of cup used.

The product length in the cup or glass can be set by two methods:

- 1 Numeric method
- 2 Visual method.

#### Numeric Method

To set the length with this method, enter the "BEVERAGE MENU" and program each available beverage using the keypad. This system requires the user to carry out a subsequent check of the actual quantity of product brewed in the cup.

The procedure for programming a cappuccino, with detailed operational sequences, is explained as an example.



**1** Switch to programming mode as described in chapter 9.

MENU
BEVERAGE MENU
MACHINE MENU

**2** Press the "☺" button (21) to access.

BEVERAGE MENU
ESPRESSO
COFFEE
CAPPUCCINO
LATTE MACCHIATO

**3** To select the "CAPPUCCINO" option, press the "☺" button (25).

BEVERAGE MENU
ESPRESSO
COFFEE
CAPPUCCINO
LATTE MACCHIATO

**4** Press the "☺" button (21) to access.

CAPPUCCINO
PREBREWING
COFFEE TEMPERATURE
COFFEE LENGTH
MILK QUANTITY

**5** Press the "☺" button (21) to access the "PREBREWING" menu.

PREBREWING
OFF
LOW
HIGH

**6** Press the "☺" button (25) or "CLEAN" button (24) button to select the desired value. Then press the "☺" button (21) to confirm and exit.

**7** Press the "☺" button (25) to select the "COFFEE TEMPERATURE" menu.

CAPPUCCINO
PREBREWING
COFFEE TEMPERATURE
COFFEE LENGTH
MILK QUANTITY

**8** Press the "☺" button (21) to access.

COFFEE TEMPERATURE
LOW
NORMAL
HIGH

**9** Press the "☺" button (25) or "CLEAN" button (24) button to select the desired value. Then press the "☺" button (21) to confirm and exit.

**10** Press the "☺" button (25) to select the "COFFEE LENGTH" menu.

CAPPUCCINO
PREBREWING
COFFEE TEMPERATURE
COFFEE LENGTH
MILK QUANTITY

**11** Press the "☺" button (21) to access.

COFFEE LENGTH
<div style="width: 10%; background-color: black; height: 10px;"></div> 185

**12** Press the "☺" button (25) or "CLEAN" button (24) to select the desired value and then let the bar advance; the number to the side identifies the bar value (**in pulses**).

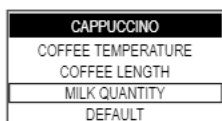

Then press the "☺" button (21) to confirm and exit.

**13** Press the  button (25) to select the "MILK QUANTITY" menu.

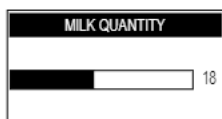

**14** Press the  button (21) to access.



**15** Press the  button (25) or  button (24) to select the desired value and then let the bar advance; the number to the side identifies the bar value (in seconds).

Then press the  button (21) to confirm and exit.

When this phase is completed, the beverage is programmed. It is recommended to perform a visual check of the result. To restore the factory settings of a single beverage, proceed as follows.

**i** Note: The factory settings can be restored for each single beverage and the restored settings will be applied only to that specific beverage. To restore the other beverages' settings, enter the menu and restore the settings.

**16** Press the  button (25) to select the "DEFAULT" menu.



**17** Press the  button (21) to access.



**i** Note: The restoring operation permanently deletes the stored data. To quit the procedure press the  button (22).

**18** Press the  button (21) to confirm.

The beverage factory settings have been restored. Press the  button (22) once or more times to exit.

### Visual Method

This method allows the product length to be set by the service provider via keypad in visual mode, i.e. the product quantity is adjusted while being brewed.

**1** Place a cup under the dispensing spout (Fig.12, page 3).

**2** Press and hold the  button (25) until the "MEMO" message is displayed, then release. The machine is now in programming mode.

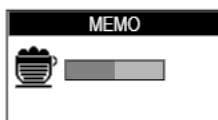

**3** The machine starts the milk dispensing phase. The "STOP MILK" message is displayed.

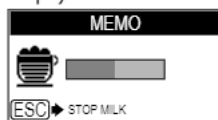

At this stage, press the  button (22) when the desired amount of milk in the cup is reached.

**4** The machine immediately begins the coffee brewing phase. The "STOP COFFEE" message is displayed.

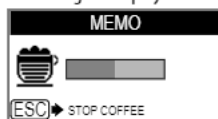

At this stage, press the  button (22) when the desired amount of coffee in the cup is reached.

Now the "☺" button (25) has been programmed. Whenever the button is pressed and released, the machine will brew the same amount that has just been set.

**i** Note: The length of all products can be programmed with this procedure, except "AMERICAN COFFEE" and "STEAM".

## 9 MACHINE PROGRAMMING



All the operations described in chapter 9 must be performed exclusively by the service provider or a specialised technician, who shall organise all the operating steps and use only suitable means to ensure strict compliance with the safety regulations in force.

The specialised technician or the service provider can change some of the machine operating parameters to suit the needs of the users.

**1** Press and hold the "☺" button for 5 seconds to access the machine main menu.

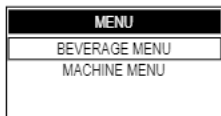

**i** Note: After 3 minutes of inactivity, the machine will exit programming mode and return to standard operating mode.

### 9.1 Programming Controls

When the machine menus are accessed, the buttons on the keypad take on new functions.

"☺" "page down/change" button (25)

This button allows you to:

- 1 browse the pages within a menu;
- 2 change the parameters when they are made editable using the "OK" button.

"☺" "page up/edit" button (24)

This button allows you to:

- 1 browse the pages within a menu;
- 2 change the parameters when they are made editable using the "OK" button.

"☺" button (21) (OK)

This button allows you to:

- 1 select the function to display;
- 2 confirm the parameter/value when it is made editable.

"☺" "ESC" button (22)

This button allows you to exit without changing the parameter edited or selected.

**Note: Press it repeatedly to exit programming mode.**

## 9.2 Beverage Menu

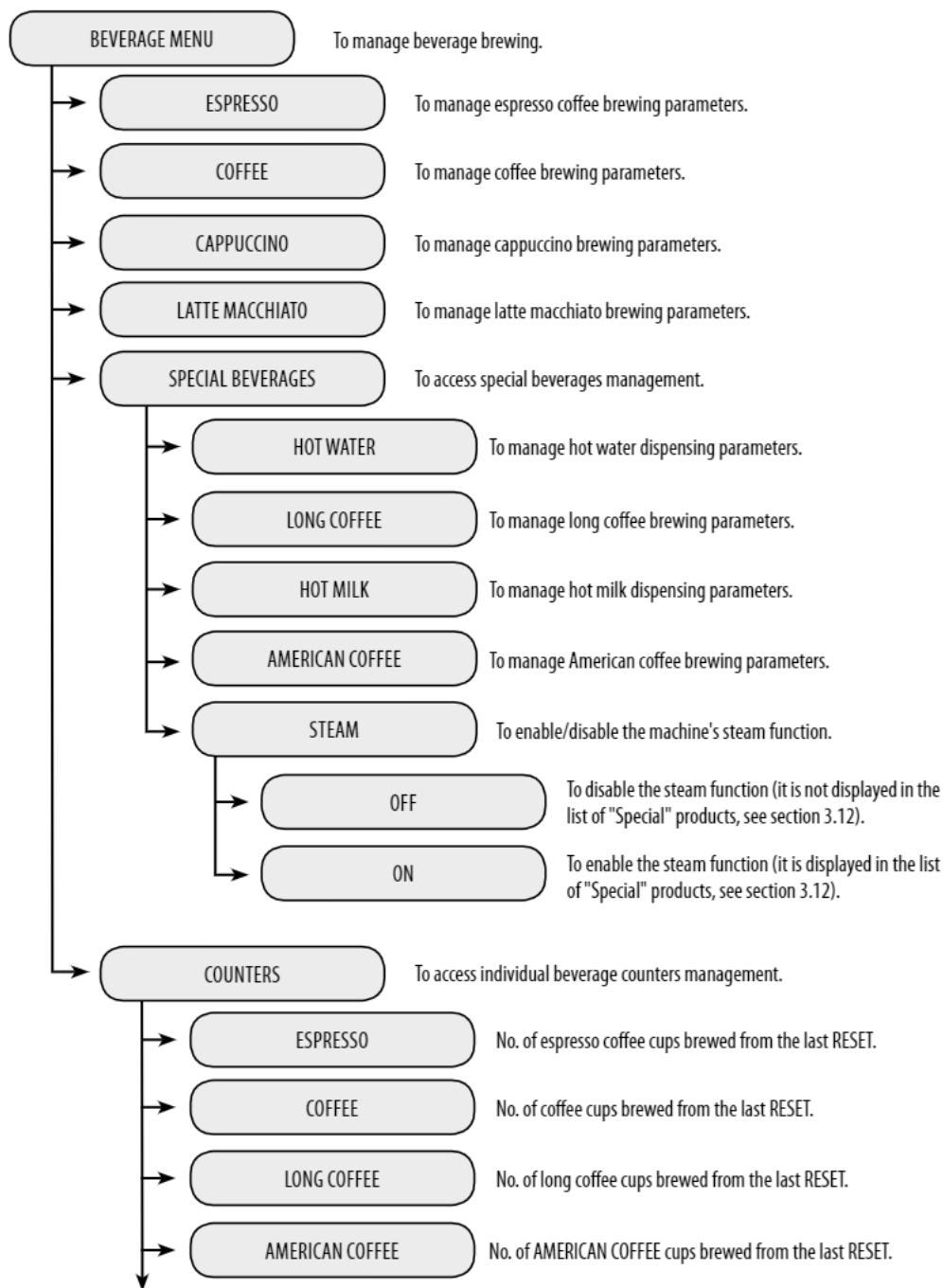

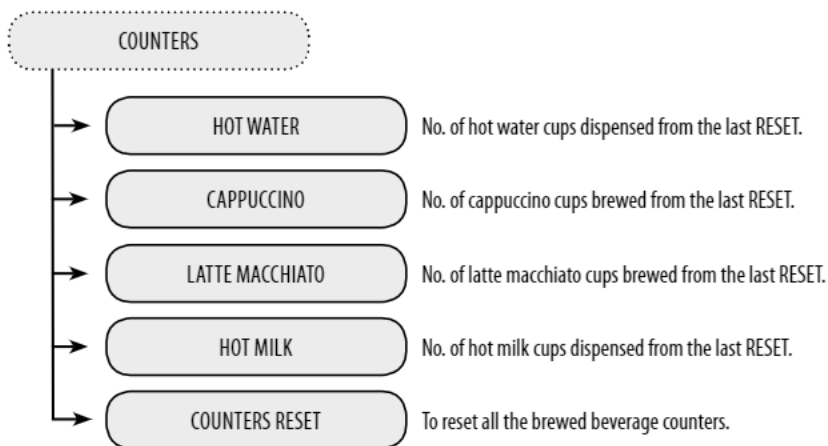

### Beverage parameters

Changeable parameters are described in this section.

**Note: Not all parameters are always available for each programmable option.**

#### PREBREWING

Prebrewing: Coffee is slightly dampened before brewing so as to bring out its full aroma and acquire an excellent taste.

OFF: prebrewing is not performed.

LOW: activated.

HIGH: longer in order to bring out the coffee taste.

#### COFFEE TEMPERATURE

This section allows the coffee brewing temperature to be programmed.

LOW: low temperature.

NORMAL: standard temperature.

HIGH: high temperature.

#### COFFEE LENGTH

This section allows you to program the amount of coffee to be brewed for each selected beverage. The bar allows you to set the exact amount of coffee to be brewed (**the value is measured in turbine pulses**).

#### MILK QUANTITY

This section allows you to program the amount of milk dispensed for each selected beverage. The bar allows you to set the exact amount of milk to be dispensed (**the value is measured in seconds**).

**These settings are valid only for programming the dispensing of milk-based beverages.**

#### WATER QUANTITY

This section allows you to set the amount of water to be dispensed when pressing the corresponding button. The bar allows you to set the exact amount of water to be dispensed (**the value is measured in turbine pulses**).

**These settings are valid only for programming hot water dispensing.**

#### DEFAULT

The original standard values assigned by the manufacturer to each beverage can be reset, according to the selected language. After selecting this function, the customised individual beverage settings are deleted.

### 9.3 Machine Menu

This menu manages general machine operation and maintenance parameters.

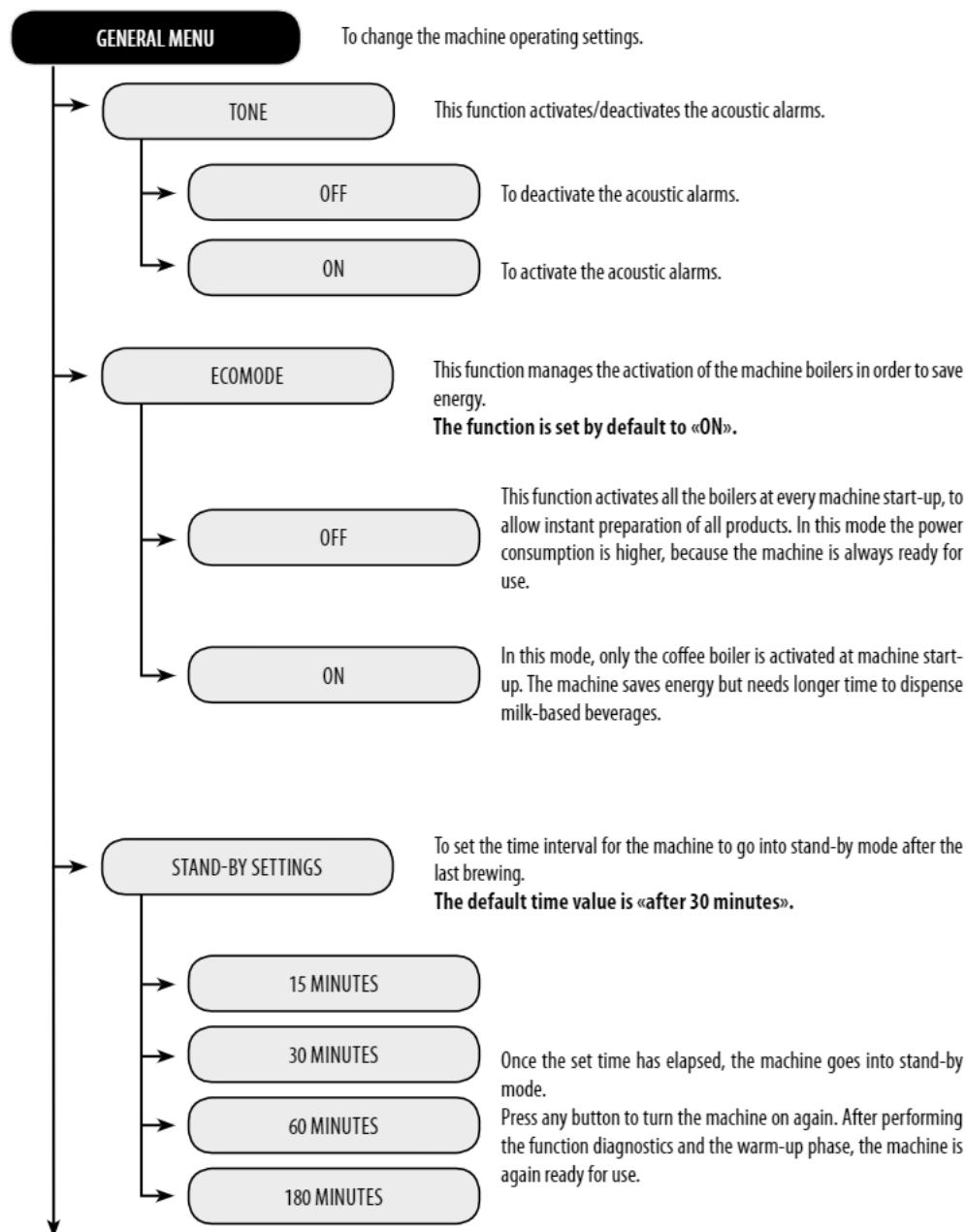

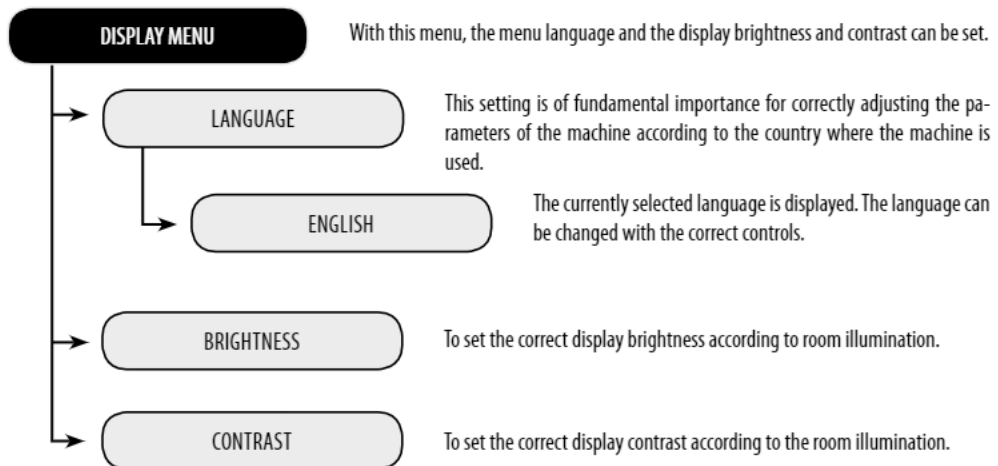
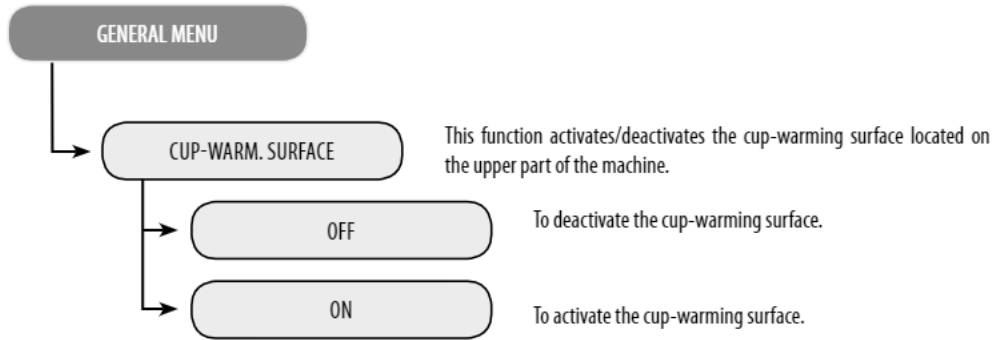

**WATER MENU**

This menu allows the correct water parameters for coffee brewing to be set.

**HARDNESS**

To change the machine water hardness setting.  
With the "Hardness" function you can adjust your machine to the level of hardness of the water you use, so that the machine will indicate descaling at the right time.

**Measure water hardness as shown in section 8.11.**

**ENABLE FILTER**

To activate/deactivate the water filter replacement warning. By activating this function, the machine notifies the user when the water filter should be replaced.

**OFF:** Warning disabled.

**ON:** Warning enabled (this value is automatically set when the filter is activated).

**ACTIVATE FILTER**

To activate the filter after its installation or replacement. Refer to section 8.12 to correctly install and/or replace the filter.



**MAINTENANCE**

This menu allows all the functions for correct machine maintenance to be set.

BREW GROUP CLEAN

This function allows you to perform the Brew Group wash cycle (see section 10.4).

DESCALING

This function starts the descaling cycle (see section 10.6).

CAPPUCCINATORE CLEANING

This function manages the cleaning cycle for the Cappuccinatore, which is used to prepare milk-based beverages (see section 10.3).

**Note: This cleaning cycle is fundamental for correct maintenance and operation of the Cappuccinatore.**

START CLEANING

This function starts the Cappuccinatore cleaning cycle as described in the relevant section.

WARNING CLEANING

This function activates the display warning message indicating that a Cappuccinatore cleaning cycle should be performed.

OFF

In this mode the warning message is disabled.

ON

In this mode the warning message is enabled. The message is displayed when a Cappuccinatore cleaning cycle should be run.

**FACTORY SETTINGS**

This function allows all factory settings to be restored.

**Note: This section allows the factory settings of the machine menu personal settings to be restored.**

### 9.4 "STEAM" Function Activation

**i** These settings are valid only for activating the steam function. When the activation is complete the menu will be available, and the user will be able to activate it by following the procedure described in section 3.12.

- 1** Switch to programming mode as described in chapter 9.

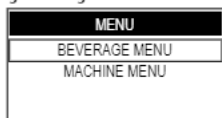

- 2** Press the "OK" button (21) to access the menu.



- 3** Press the "SPECIAL BEVERAGES" button (25) and select the "SPECIAL BEVERAGES" option.

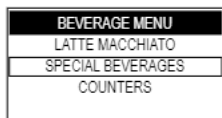

- 4** Press the "OK" button (21) to access the menu.

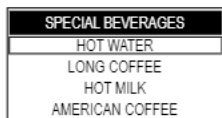

- 5** Press the "STEAM" button (25) until the "STEAM" option is selected.

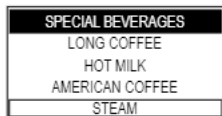

- 6** Press the "OK" button (21) to confirm.

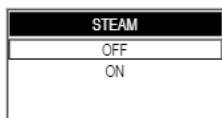

- 7** Press the "OK" button (25) until the "ON" option is selected.

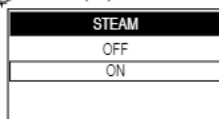

- 8** Press the "OK" button (21) to confirm.

At this point, the steam function is enabled and will now be available for special beverages.

Press the "ESC" button (22) multiple times to exit the programming mode.

### 9.5 "WARNING CLEANING" Function Activation

With this function, a message reminding the user to clean the Cappuccinatore immediately after use can be displayed.

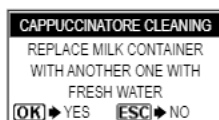

This message will appear each time that the machine dispenses a milk-based product using the Cappuccinatore.

- 1** Switch to programming mode as described in chapter 9.

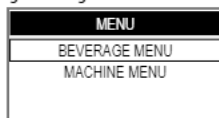

- 2** To select the "MACHINE MENU" option, press the "OK" button (25).

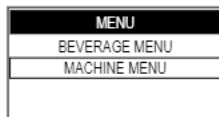

- 3** Press the "OK" button (21) to access.

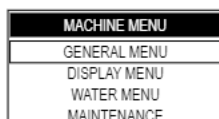

**4** Press the "☺" button (25) and select the "MAINTENANCE" option.

<b>MACHINE MENU</b>
DISPLAY MENU
WATER MENU
MAINTENANCE
FACTORY SETTINGS

**i** **Note:** The message will not be displayed if a cleaning cycle is run immediately after dispensing a milk-based product.

Press the "☺" button (22) multiple times to exit the programming mode.

**5** Press the "☺" button (21) to confirm.

**6** Press the "☺" button (25) until the "CAPPUCCINATORE CLEANING" option can be selected.

<b>MAINTENANCE</b>
BREW GROUP CLEAN
DESCALING
CAPPUCCINATORE CLEANING

**7** Press the "☺" button (21) to confirm.

**8** Press the "☺" button (25) and select the "WARNING CLEANING" option.

<b>CAPPUCCINATORE CLEANING</b>
START CLEANING
WARNING CLEANING

**9** Press the "☺" button (21) to access the menu.

<b>WARNING CLEANING</b>
OFF
ON

**10** Press the "☺" button (25) until the "ON" option is selected.

<b>WARNING CLEANING</b>
OFF
ON

**11** Press the "☺" button (21) to confirm.

At this point the warning function is enabled and will be displayed 10 minutes after each milk-based product is dispensed.

## 10 CLEANING AND MAINTENANCE



All the operations described in chapter 10 must be performed exclusively by the service provider or a specialised technician, who shall organise all the operating steps and use only suitable means to ensure strict compliance with the safety regulations in force.

### 10.1 Cleaning Intervals

For improved efficiency, it is advisable to carry out the cleaning and maintenance operations indicated in the following table.

Operation to be carried out	When an alert is shown	Weekly	Every month or 500 brewing cycles
Emptying and cleaning the coffee grounds drawer	■		
Thorough cleaning of the Cappuccinatore			■
Water tank cleaning		■	
Brew group cleaning		■	
Brew group lubrication			■
Coffee bean hopper cleaning			■
Descaling	■		

### 10.2 Cleaning the Water Tank

The water tank should be cleaned every week.

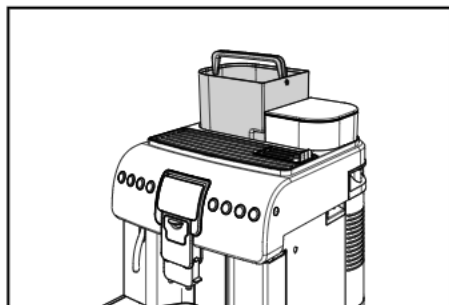

### 10.3 Thorough Cleaning of the Cappuccinatore

Clean all the Cappuccinatore parts thoroughly every month using Saeco detergent.

Saeco detergent may be purchased at your local dealer or at authorised service centres.

The lack of cleaning before and after each use can affect the correct operation of the machine.



**Danger of scalding! Dispensing may be preceded by small jets of hot water.**

**1** Ensure that the Cappuccinatore is correctly positioned (Fig.09-10, page 3).

**2** Switch to programming mode as described in chapter 9.

**3** Press the "☕" button (25) and select the "MACHINE MENU" option.  
Press the "OK" button (21) to access the menu.

**4** Press the "☕" button (25) and select the "MAINTENANCE" option.  
Press the "OK" button (21) to access the menu.

MACHINE MENU
DISPLAY MENU
WATER MENU
MAINTENANCE
FACTORY SETTINGS

**5** Press the "☕" button (25) until the "CAPPUCCINATORE CLEANING" option can be selected.

MAINTENANCE
BREW GROUP CLEAN
DESCALING
CAPPUCCINATORE CLEANING

Press the "OK" button (21) to confirm.

CAPPUCCINATORE CLEANING
START CLEANING
WARNING CLEANING

Press the "OK" button (21) to confirm.

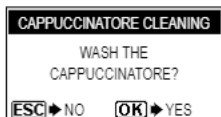

**i** Note: If this option is confirmed, the cycle must be completed. Press the "OK" button (22) to exit.

**6** Press the "OK" button (21) to start the Cappuccinatore cleaning cycle.

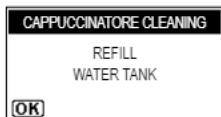

**7** Fill the water tank and press the "OK" button (21) to confirm.

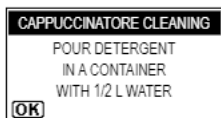

**8** Pour a sachet of solution into a container with 1/2 (half) litre of fresh drinking water.

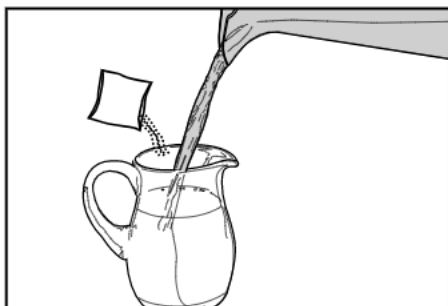

**9** Wait for the contents of the sachet to dissolve completely and then press the "OK" button (21) to confirm.

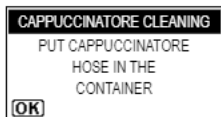

**10** Insert the clean pipe directly into the container.

**11** Press the "OK" button (21) to confirm.

**!** Do not drink the solution dispensed during this procedure. The solution must be disposed of.

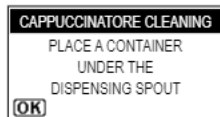

**12** Place an empty container of at least 1 litre capacity under the dispensing spout and press the "OK" button (21) to confirm.

**13** The machine performs a Cappuccinatore wash cycle.

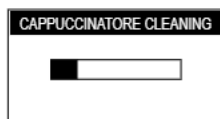

The bar shows the washing progress.

**14** Wait for the cycle to end automatically. When the cycle is completed, the display shows:



**15** Wash the water tank and fill it with fresh drinking water; press the "OK" button (21) to confirm.

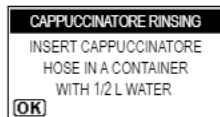

**16** Wash the container used for the solution thoroughly and fill it with 1/2 (half) litre of fresh drinking water which will be used for rinsing.

**17** Empty the container placed under the dispensing spout.

**18** Insert the suction hose in the container used. Press the "OK" button (21) to confirm.

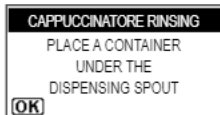

**19** Place an empty container under the dispensing spout and press the  button (21) to confirm.

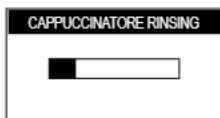

**20** The machine performs a Cappuccinatore rinse cycle. The bar shows the rinsing progress.

**21** Wait until the cycle stops automatically. The machine will go back to the normal operating cycle.

**22** Wash all the Cappuccinatore parts as described in section 5.4.

**i** **Important note:** It is advisable to remove the Cappuccinatore from the machine when not being used, in order to keep it clean.

#### 10.4 Brew Group Cleaning with the "Coffee Oil Remover System"

As well as weekly cleaning, we recommend running the cleaning cycle with the "Coffee Oil Remover system" after approximately 500 cups of coffee or once a month.

This operation completes the maintenance process of the brew group.



Both the "Coffee Oil Remover system" used to clean the Brew Group and the "Maintenance Kit" may be purchased at your local dealer or at authorised service centres.



**Warning:** The "Coffee Oil Remover system" has no descaling properties. To descale, use the Saeco descaling solution and follow the procedure described in the "Descaling" chapter.

The wash cycle cannot be interrupted. Do not leave the machine unattended during this operation.

**Warning!** Do not drink the solution dispensed during this procedure. The solution must be disposed of.

**1** Switch to programming mode as described in chapter 9.

**2** Press the  button (25) and select the "MACHINE MENU" option. Press the  button (21) to access the menu.

**3** Press the  button (25) and select the "MAINTENANCE" option. Press the  button (21) to access the menu.

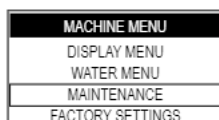

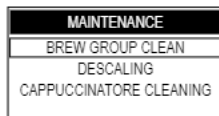

**4** Press the  button (21) to access the menu.

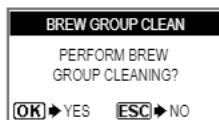

**5** Press the  button (21) to access the Brew Group cleaning cycle.



**i** **Note:** If this option is confirmed the cycle must be completed. Press the  button (22) to exit.

**6** Press the  button (21) to start the brew group cleaning cycle.

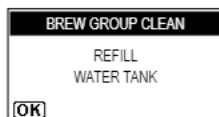

**7** Fill the water tank and press the "☕" button (21) to confirm.

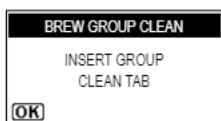

**8** Insert the cleaning tablet in the pre-ground coffee compartment.

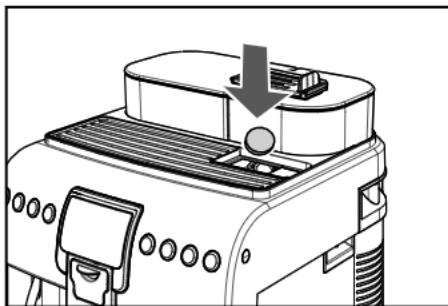

**9** Having inserted the cleaning tablet, press the "☕" button (21) to confirm.

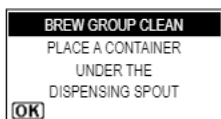

**10** Place a container under the dispensing spout and press the "☕" button (21) to confirm.

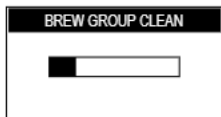

**11** The machine completes the cycle automatically.

**i** Note: At the end of the cycle the machine goes back to its normal operating mode. It is recommended to remove the group and wash it under fresh running water.

## 10.5 Brew Group Lubrication

Lubricate the Brew group after approximately 500 cups of coffee or once a month.

The grease to lubricate the brew group and the complete "Service Kit" can be purchased at your local dealer or at authorised service centres.

**i** Note: To display the number of coffee cups brewed, please refer to the "COUNTERS" menu in the "BEVERAGE MENU" (see section 9.2).

Before lubricating the brew group, clean it under running water as described in the "Brew Group - Weekly Cleaning" chapter.

**1** Lubricate the brew group guides using Saeco grease only.

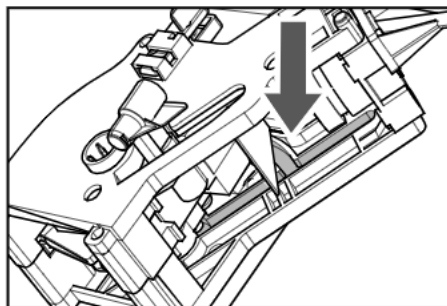

Apply the grease evenly on both side guides.

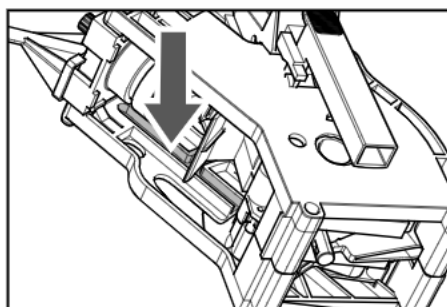

**2** Also lubricate the shaft.

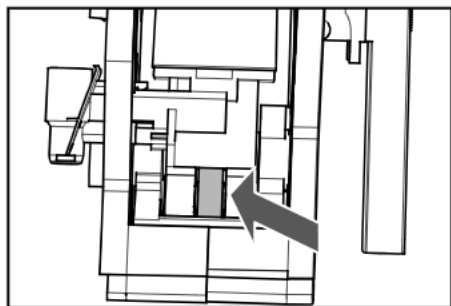
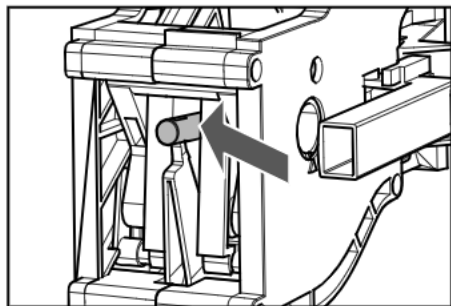

**3** Insert the Brew Group back into its seat until it locks into place, **WITHOUT** pressing the "PRESS" button.

**4** Insert the coffee grounds drawer and the drip tray. Close the service door.

## 10.6 Descaling

Limescale is a natural part of the water used for machine operation. It needs to be removed regularly as it may clog the water and coffee circuit of your appliance.

The advanced electronics shows on the machine display (with clear icons) when descaling is needed. Just follow the steps described below.

This operation needs to be carried out before the appliance stops working properly, as in this case repair is not covered by warranty.

Use the Saeco descaling product only. Its formula has been specifically designed to ensure better machine performance and operation for its whole operating life. If correctly used, it also avoids alterations in the brewed product.

The descaling solution and the complete "Maintenance Kit" may be purchased at your local dealer or at authorised service centres.

**Warning!** Never drink the descaling solution or any products brewed until the cycle has been completed. Never use vinegar as a descaling solution.

**1** Turn on the machine by pressing the ON/OFF button. Wait for the machine to complete the rinse and warm-up process.

**Warning!** Remove the "Intenza" filter before adding the descaling solution.

**2** Switch to programming mode as described in chapter 9.

**3** Press the "☕" button (25) and select the "MACHINE MENU" option.  
Press the "☕" button (21) to access the menu.

MACHINE MENU
DISPLAY MENU
WATER MENU
MAINTENANCE
FACTORY SETTINGS

**4** Press the "☕" button (25) and select the "MAINTENANCE" option.  
Press the "☕" button (21) to access the menu.



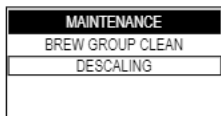

**5** Press the button (25) and select the "DESCALING" option; press the button (21) to enter the menu.

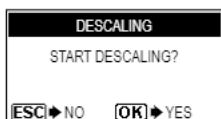

**i** Note: If this option is confirmed, the whole cycle must be completed. Press the button (22) to exit.

**6** Press the button (21) to start the DESCALING cycle.

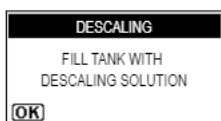

**7** Pour the entire contents of the bottle of Saeco concentrated descaling solution into the water tank and fill the tank with fresh drinking water up to the level indicated by the icon.

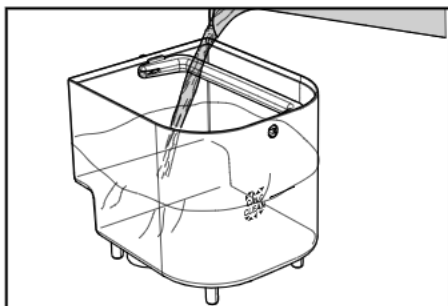

**8** Place the tank back in the machine. Press the button (21).



**9** Remove any liquids from the drip tray and place it back in the machine.

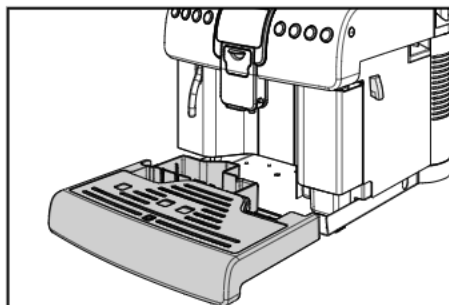

Press the button (21).

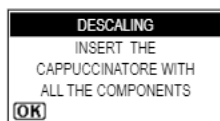

**10** Insert the complete Cappuccinatore into the machine and remove the dispensing spout.

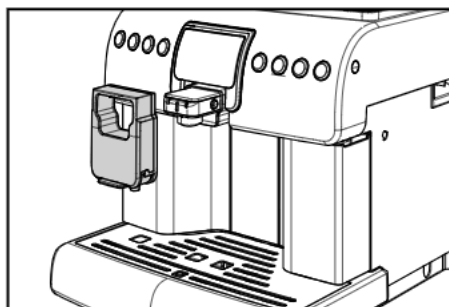

Press the button (21).

**i** Note: The suction tube must be removed from the Cappuccinatore while the descaling cycle is performed.

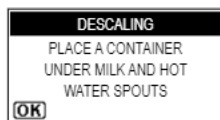

**11** Place a container under the hot water wand and a large container under the Cappuccinatore.

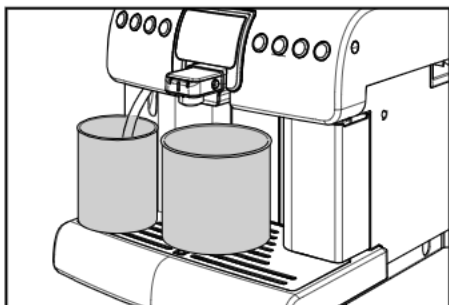

**i** Note: Use a container of at least 1.5 litres capacity.

Press the "☕" button (21).

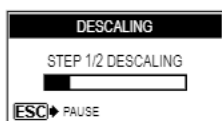

**i** If you do not have a container of this capacity, pause the cycle by pressing the "☕" button (22), empty the container, place it back in the machine and re-start the cycle by pressing the "☕" button (21).

**12** At this point, the machine will start dispensing the descaling solution at intervals (the bar shows the cycle progress).

**13** When the solution in the tank is finished, empty and rinse the tank with fresh drinking water, as indicated by the machine.

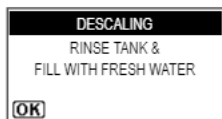

**14** Rinse the water tank thoroughly and refill it with fresh drinking water.

**15** Insert the tank into the machine. Press the "☕" button (21).

**16** Empty the containers used to collect the liquid dispensed by the machine.

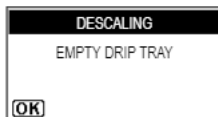

**17** Remove any liquids from the drip tray and insert the tray back into the machine.

Press the "☕" button (21).

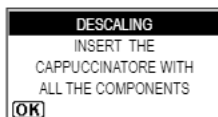

**18** Check that the Cappuccinatore is placed in the machine.

Press the "☕" button (21).

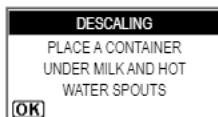

**19** Place a container under the hot water wand and a large container under the Cappuccinatore.

Press the "☕" button (21).

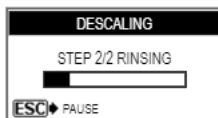

**20** The machine performs the rinse cycle.

**i** Note: A default amount of water is needed for the rinse phase. This allows an ideal rinse cycle to be performed in order to ensure the best conditions to brew products. A message to fill the water tank will be displayed throughout the rinse cycle. This is normal and part of the procedure.

**i** Note: The rinse cycle can be paused by pressing the "☕" button (22). To resume the cycle, press the "☕" button (21) again. This allows you to empty the container or to leave the machine unattended for a short time.

**21** Once the rinse cycle is complete, the machine carries out the warm-up and rinse cycle to be ready for product brewing.

**22** Empty the containers used to collect the liquid dispensed by the machine and reassemble the dispensing spout.

**23** The machine is now ready for use.



Note:

- **The descaling solution must be disposed of according to the manufacturer's instructions and/or regulations in force in the country of use;**
- **after completing the descaling cycle:**
  - 1 Wash the brew group as described in the "Brew Group - Weekly Cleaning" section in the "Cleaning and Maintenance" chapter;**
  - 2 Rinse the Cappuccinatore under running water.**

When the descaling cycle is complete, it is recommended to empty the drip tray.

## 11 MACHINE DISPOSAL

In compliance with art. 13 of the Italian Legislative Decree dated 25 July 2005, no. 151 "Implementation of the Directives 2002/95/EC, 2002/96/EC and 2003/108/EC on the restriction of the use of certain hazardous substances in electrical and electronic equipment, as well as waste disposal".



The symbol of the crossed-out wheeled bin  on the appliance or its packaging indicates that the product must be disposed of separately from other waste at the end of its operational life. The user must therefore take the appliance to be disposed of to a suitable recycling centre for electronic and electrotechnical equipment, or alternatively hand it over to the vendor on a one on one exchange, when purchasing a new appliance of similar type. Separating this product for subsequent recycling, treatment and environmentally-friendly disposal will help prevent potential environmental and health risks, and allow the materials which make up the appliance to be re-used and/or recycled. Incorrect or irresponsible disposal of this product could lead to administrative sanctions being imposed on the user in accordance with current regulations.

## 12 TROUBLESHOOTING

Machine actions	Causes	Solutions
The machine does not turn on.	The machine is not plugged in and/or the power button is positioned on "0".	Plug in the machine and/or switch the power button to "1".
Coffee is not hot enough.	The cups are cold.	Preheat the cups with hot water.
	Cup-warming surface deactivated.	Activate the cup-warming surface and wait for the cups to warm.
Coffee does not have enough crema. (see note).	The blend is unsuitable, coffee is not freshly roasted or the grind is too coarse.	Change coffee blend or adjust the grind as explained in the "Adjusting the Coffee Grinder" section.
The machine takes a long time to warm up or the amount of water dispensed from the wand is too little.	The machine circuit is clogged by limescale.	Descale the machine.
Bubbles form at the Cappuccinatore spout while dispensing milk.	The tube fittings are not properly connected or not completely inserted in the Cappuccinatore and/or Thermos.	Insert the whole suction tube into the Cappuccinatore.
Steam comes out of the Cappuccinatore when sucking milk.	There is no more milk in the container.	Check that there is still milk. If necessary, replace the milk container with a new one.
The Brew Group cannot be removed.	The Brew Group is out of place.	Turn on the machine. Close the service door. The brew group automatically returns to the initial position.
	Coffee grounds drawer inserted.	Remove the coffee grounds drawer before removing the brew group.
The machine grinds the coffee beans but no coffee comes out. (see note).	The Brew Group is dirty.	Clean the Brew Group ("Brew Group - Weekly Cleaning" section).
	The dispensing spout is dirty.	Clean the dispensing spout.
Coffee is too weak. (see note).	Dose is too low.	Adjust the amount of coffee to be ground.
Coffee is dispensed slowly. (see note).	The coffee grind is too fine.	Change coffee blend or adjust the grind as explained in the "Adjusting the Coffee Grinder" section.
	The Brew Group is dirty.	Clean the Brew Group ("Brew Group - Weekly Cleaning" section).
Coffee leaks out of the dispensing spout.	The dispensing spout is clogged or in the wrong position.	Clean the dispensing spout and its holes. Position the dispensing spout correctly.

**Note:** These problems can be considered normal if the coffee blend has been changed or if the machine has just been installed.

Please contact our consumer care help line on the phone number listed on the last page of this document for any problems not covered in the above table, or when the suggested solutions do not solve the problem.

02

- Rev.01 15-07-13



421940439961

EN

02

The manufacturer reserves the right to make changes without prior notice.

